

← A Coil
made up for
stowing

143. To break a heavy cord or string, take a turn of the cord around the left palm. Revolve the left hand so the cord is twisted in front of the palm, and wind the standing part several times around the fingers. Wrap the end (which is longer than illustrated) several times around the right hand; hold everything firm and jerk stoutly.

In each of the two methods given the string crosses itself at right angles, one part being held rigidly while the other part is strongly jerked.

My first impression was that the weakening effect of this harsh crossing was the important factor in causing the string to break invariably at this point. One of the "laws" quoted in dictionary and encyclopedia knot discussions is that "the strength of a knot depends on the ease of its curves," and of course a right-angle crossing provides the uneasiest curve that is possible within a knot.

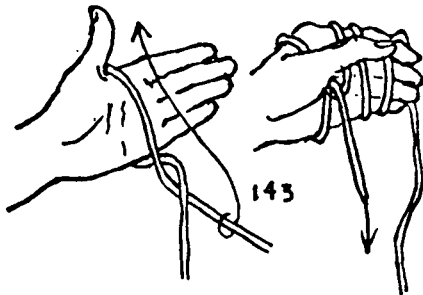

For joining structural members that will receive constant wear, use synthetic ropes such as Nylon or Dacron, since they are strong and rot resistant. Nylon is best for making lashings to a tree, because it has some elasticity. One synthetic rope to avoid is polypropylene, which degrades in the sun, makes slippery knots, and in time produces tiny sharp “whiskers” that can cut your hands. Also, be careful about using manila rope. Although it is made of natural fibers, manila hemp has a tendency to rot from within, making the user unaware of its defects until a load is applied and it’s too late!



Overhand knot

Sometimes used as a stop knot or to keep the end of a rope from unraveling

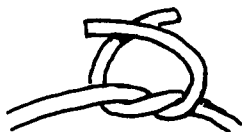

Square knot

Most popular knot — used for tying everything from packages to payloads

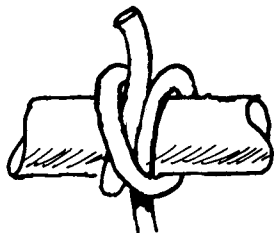
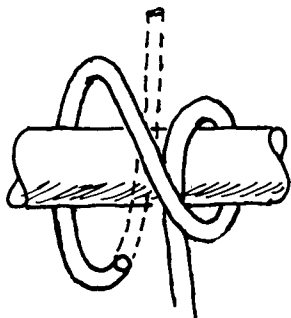

Clove hitch

Gets tighter as you pull on it, but comes apart easily when the pressure is released

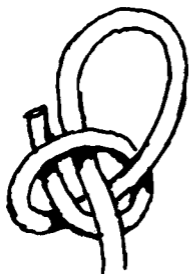

Slip knot

Constricts around the object it is tied to

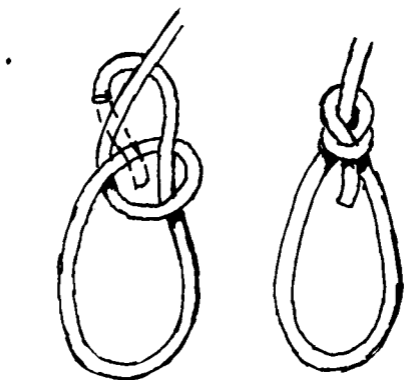

Bowline

A very secure seaman's knot used for slipping over pilings and posts

KNOTS

It is important to select the right knot for the task in hand. You never know when you may need to tie a knot, so learn their uses and how to tie – and untie – each one.

In the instructions for individual knots that follow the end of the rope or cord being used to tie the knot is referred to as the 'live end' to distinguish it from the other end of the rope, or 'standing part'.

REEF KNOT: Use to tie ropes of same thickness. Holds firm under strain, yet is easily untied. It is not reliable for ropes of different diameters, nor for nylon. Can be tied in other materials – use in first aid. It will lie flat against the patient.

Pass right end over left (a) and then under it (b). Take left over right (c) and under it (d).

Check – the 2 loops should slide on each other. Tighten by pulling both strands on each side (e). To be doubly sure, finish by making a half-hitch with the live ends on either side of the knot (f).

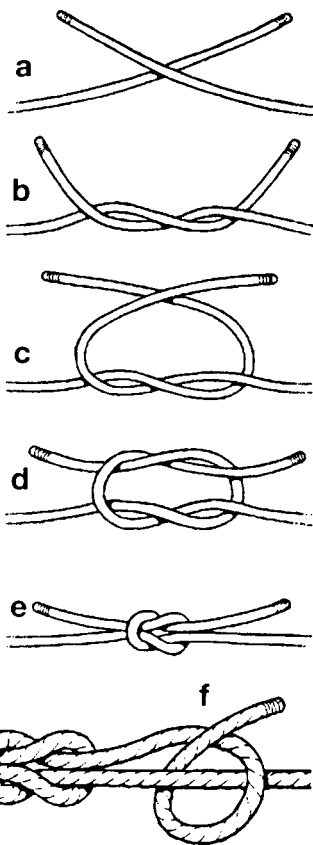

Simple knots

These knots are quickly made and will help you understand the more complicated knots that follow.

OVERHAND KNOT: Make a loop and pass the live end back through it.

OVERHAND LOOP: Fixed loop for throwing over a projection. Double the end of rope and tie overhand knot with the loop.

FIGURE-OF-EIGHT: An end-stop. Make a loop. Carry live end first behind, then round, standing part. Bring it forward through the loop.

FIGURE-OF-FIGHT LOOP: Made in the same way as the figure-of-eight, but with line doubled, using loop as the live end. Can be used over a spike anchor for a belaying rope.

REWOVEN FIGURE-OF-EIGHT: Use when top end of a projection is out of reach. Make loose figure-of-eight along the rope. Pass live end round anchor and feed it back round the figure-of-eight, following exactly. Ease tight.

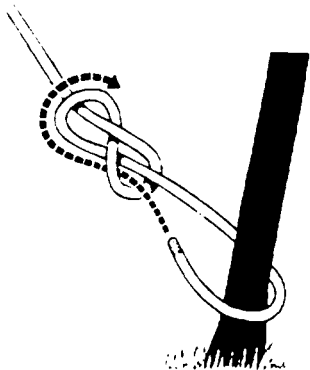
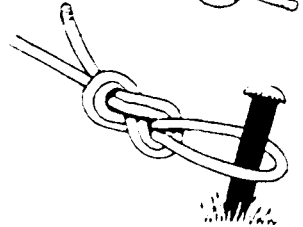
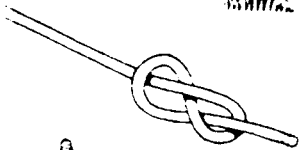
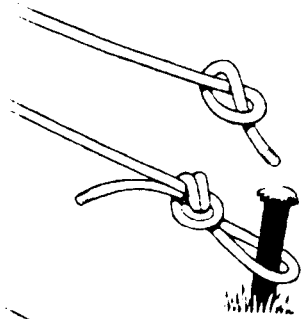

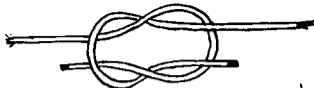

Square Knot

Clove Hitch

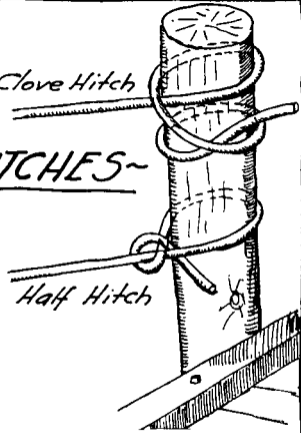

~KNOTS & HITCHES~

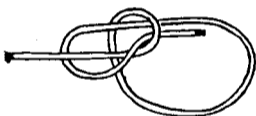

Bowline

Half Hitch

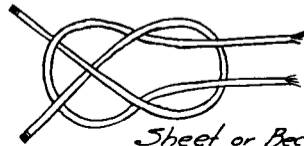

Sheet or Becket Bend.

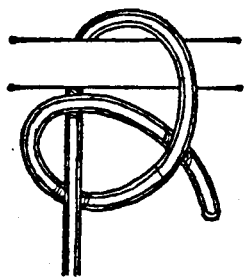

(a) half-hitch

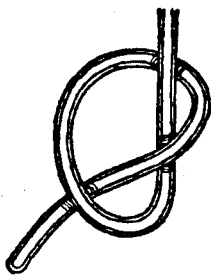

(b) overhand



(c) figure-of-eight

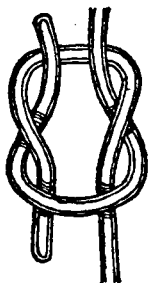

(d) reef knot

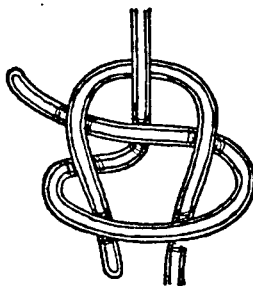

(e) weaver's knot

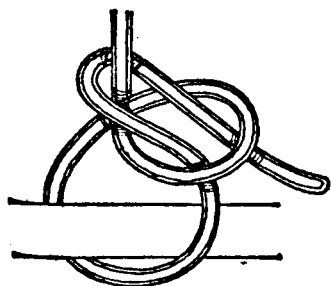

(f) bowline

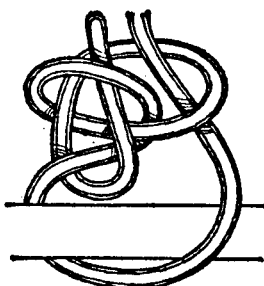

(g) running bowline

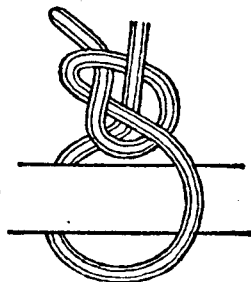

(h) running knot

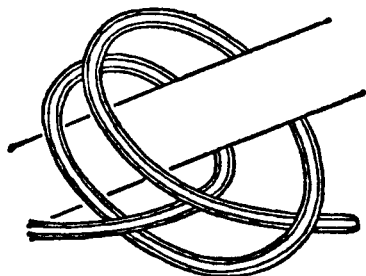

(i) clove hitch

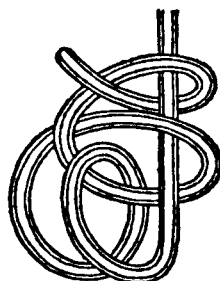

(j) rolling hitch

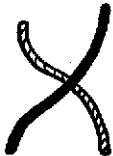

weaver's knot

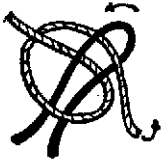



(A) overhand knot



(B) slipknot

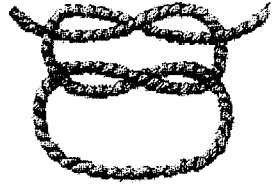

(C) square knot

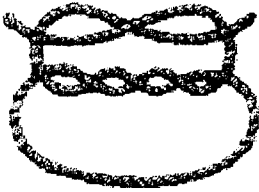

(D) surgeon's knot

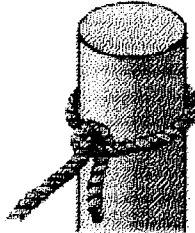

(E) half hitch



(F) Blackwall hitch



(G) cat's-paw

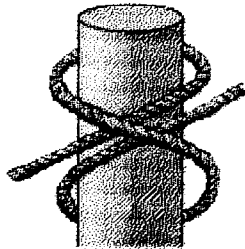

(H) clove hitch

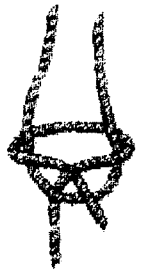

(I) sheet bend

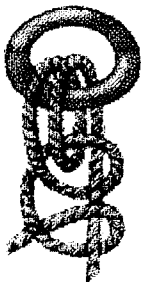

(J) fisherman's bend



(K) sheepshank



(L) bowline

BASIC KNOTS



BOWLINE (above): This knot will not slip and is ideal for tying two ropes together, for fastening a rope to a pole and for rescue operations. Form closed loop in rope, bring end of line up through loop, around standing end of rope and back down through loop. Pull tight.

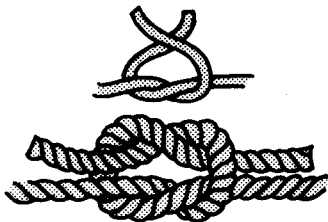

SQUARE KNOT: The basic tie for joining two ropes, also called a *reef knot*. Make by forming first a right and then a left overhand knot. Much easier to untie and far superior in holding strength than the granny knot, which it closely resembles.



GRANNY KNOT

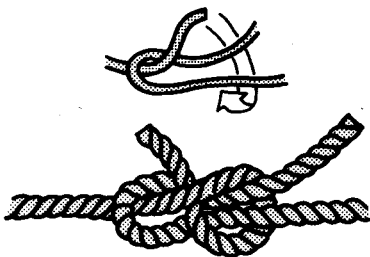

SHEETBEND: The best knot for joining two ropes, especially when they differ in size. Form a bight (loop) in the larger line. Bring the smaller through the bight, around the doubled heavier cord and back under itself.



CLOVE HITCH: Easy to tie and untie. Holds well. This is one of the most useful of all hitches for fastening tent ropes and guys to stakes or poles.

OUTDOOR KNOTS

HALF HITCH: For temporarily fastening a line to a pole (Fig. 1).

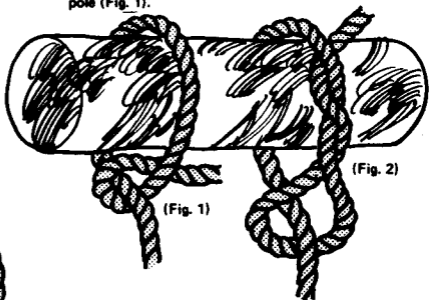

TIMBER HITCH: A half hitch modified to hold more securely (Fig. 2).

COMBINATION HALF AND TIMBER HITCH: Ideal for applying a straight end pull to a pole or pipe. Tie the half hitch first, timber hitch second.

CAT'S PAW (above): A good way to secure a rope to a hook. Throw a double loop in the line, twist both ends twice and slip them over the hook.

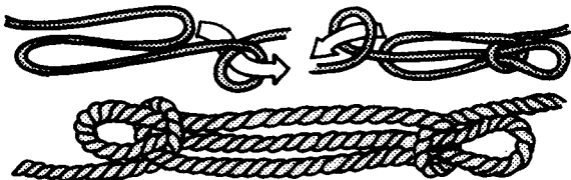
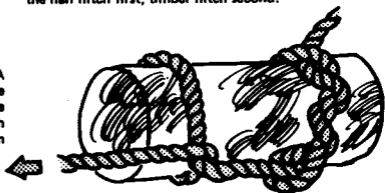

SHEEPSHANK: Downright handy for shortening a line without untying it. Follow the diagrams and you can't go wrong. The hitch may be fastened permanently by passing the ends of the rope through the loops.

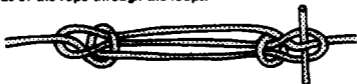

BOATING KNOTS



Fig. 2

BELAYING TO A PIN OR CLEAT: It's always best to make a first turn to take the strain before making one or two figure eight turns to temporarily hold the load (Fig. 1). For more permanent fastening, finish with a half hitch (Fig. 2).

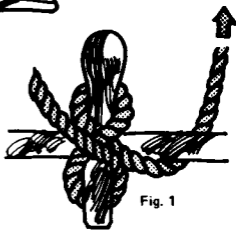
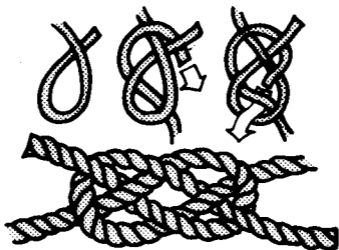

Fig. 1



CARRICK BEND: A strong joining knot. Cross a bight on one rope and work the end of the second line around it in a regular under-and-over manner. Note that at no time does a line pass through a loop.

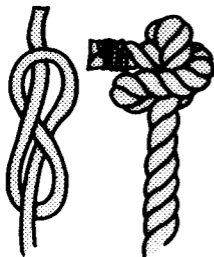
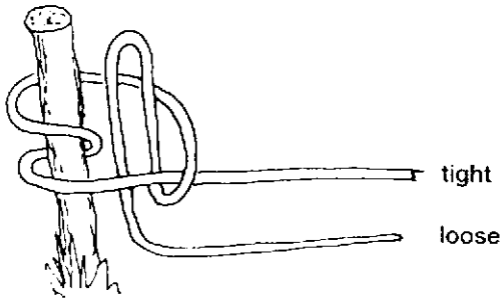
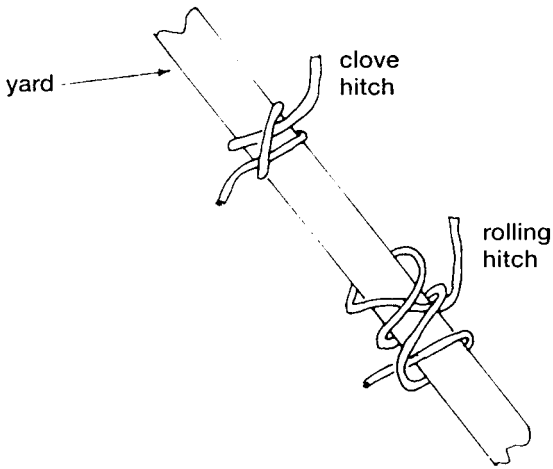

FIGURE EIGHT: Useful as a convenient handhold and for preventing ropes from running through a hole or pulley. Form by throwing a loop near the end of a line, bringing the short end completely around the standing part of the rope and back through the loop. Pull tight.



a round turn and a slipped
half-hitch.



yard

clove
hitch

rolling
hitch

Joining ropes

SHEET BEND: If correctly made and strain is not erratic this won't slip.

1 Make a loop in one rope. Take live end of the other (a) right round behind loop to the front, carry it over itself and then tuck down through loop. 2 Draw it tight and ease into shape as strain is increased.

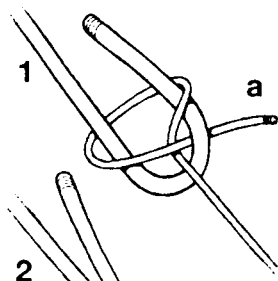

DOUBLE SHEET BEND: More secure variation of sheet bend — use on wet ropes and where strain is not constant.

1 Make a loop in the thicker rope. Take live end of thinner rope (a) through loop, beneath thicker live end and then forward on outside of loop and right round it. Bring thin live end back between itself and outside of thick loop. 2 Take thin live end completely round the loop again and back through same place on outside of thick loop. 3 Draw tight and ease into shape.

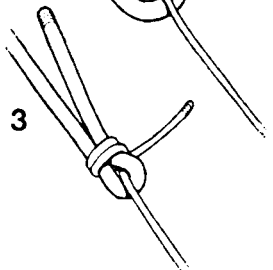
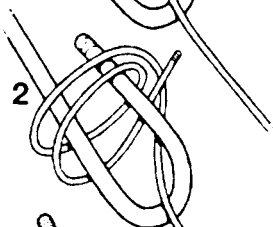
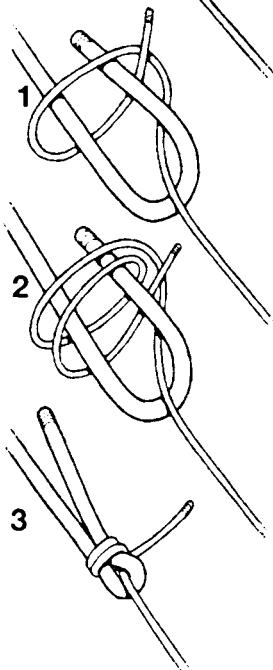

If not tightened these knots tend to work loose. Do not use with smooth lines, e.g. nylon fishing line.

FISHERMAN'S KNOT: Ideal for joining springy vines, wires, slippery lines and gut fishing line (soak gut first to make it pliable). Very secure but hard to untie. Not recommended for bulky ropes or nylon line.

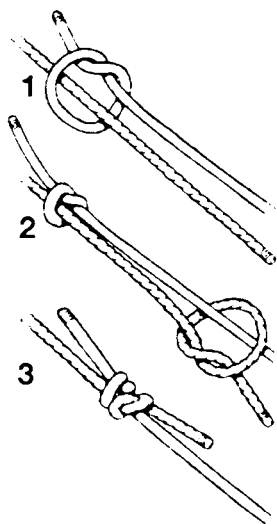

1 Lay lines beside each other, the ends in opposite directions. Carry live end of one line round the other and make a simple overhand knot. 2 Repeat with live end of other line.

3 Partially tighten knots and slide towards each other. Ease them to rest against one another, completing tightening process.

DOUBLE FISHERMAN'S: Stronger version of the above. Do not use for nylon fishing lines, nylon ropes, or bulky ropes.

1 Carry live end of one line round the other, then round both. 2 Carry live end back through the two loops.

3 Repeat with the end of the other line. 4 Slide the 2 knots together and tighten, easing them to rest well against each other. Apply strain gradually.

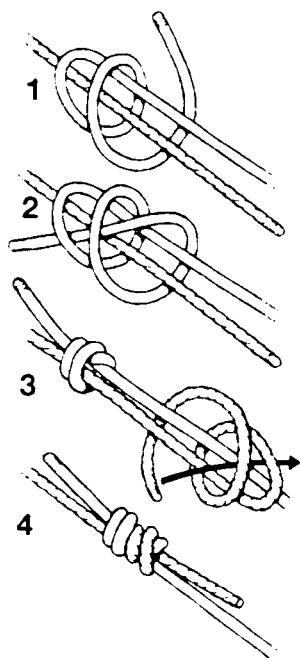

TAPE KNOT: Use to join flat materials, e.g. leather, webbing, tape and sheets or other fabrics.

1 Make an overhand knot in the end of one tape. Do not pull it tight. 2 Feed the other tape through it so it follows exactly the shape of the first knot. 3 Live ends should be well clear of the knot so that they will not slip back when you tighten it.

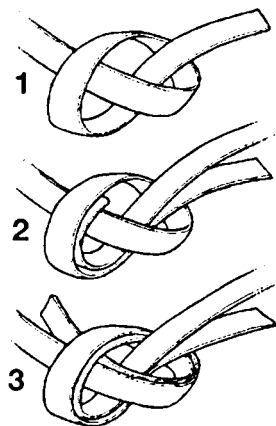

Loop making

BOWLINE: A fixed loop that will neither tighten nor slip under strain. Use at the end of a lifeline.

1 Make a small loop a little way along the rope. 2 Bring live end up through it, round standing part and back down through loop. 3 Pull on live end to tighten, easing knot into shape. Finish with a half-hitch.

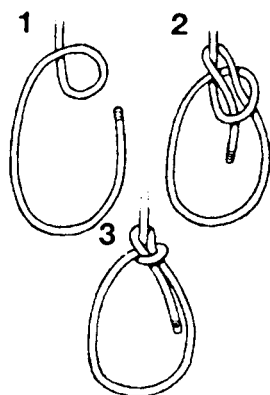

RUNNING BOWLINE: A loop which tightens easily. Make a small bowline and pass long end of rope through loop.

Never tie a running bowline round the waist, it acts like a hangman's noose and could kill.

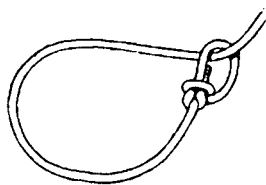

TRIPLE BOWLINE: A bowline made with a double line. Form a loop, pass doubled live end through loop, behind standing part and back through loop. This produces 3 loops which can be used for equipment haulage, or as a sit-sling or lifting harness with one loop round each thigh and the other round the chest. It takes practice - learn it before you need to use it.

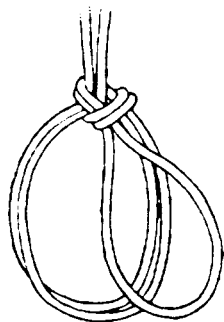

BOWLINE-ON-THE-BIGHT: To support or lift someone from a crevasse. The loops will neither tighten nor jam, forming a bosun's chair, one loop fitting round buttocks, the other round upper body. Practice before you need to use it.

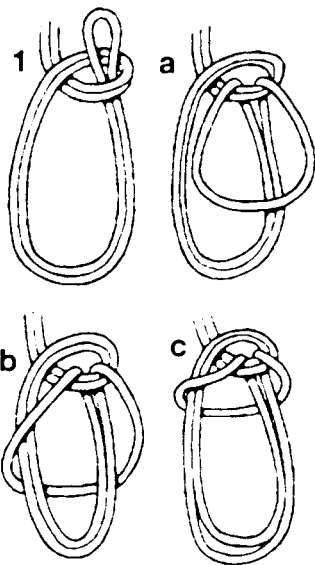

1 Using doubled line, form a loop and pass the live end through it. 2 Bring this end down (a) and over the end (b) of the larger double loop now formed. Ease it back up to behind the standing part (c). Pull on the large double loop to tighten (d).

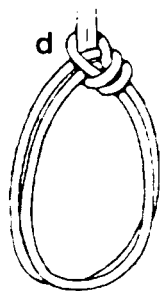

Anchor bend ■ 210

To connect a warp with a ring or anchor.

■ 210 *Anchor bend*

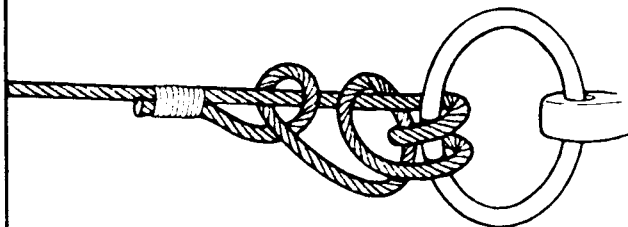

Bowline ■ 211

Wherever a bight is needed.

See: Bowline – for a one-handed method.

■ 211 *Bowline*

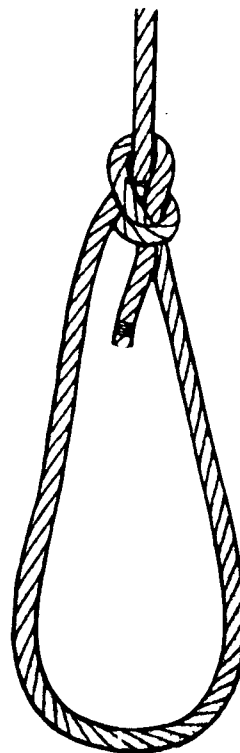
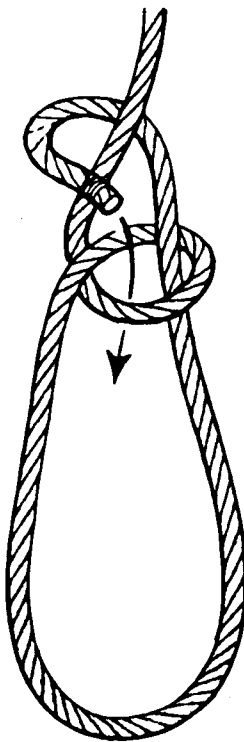
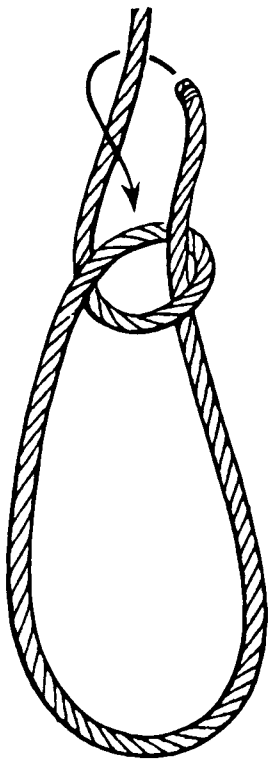

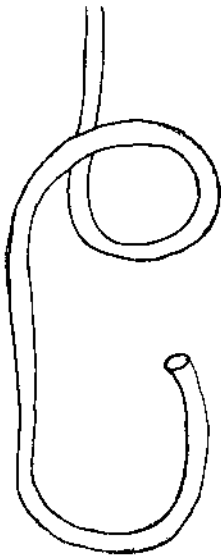

ONCE THERE WAS A SNAKE
WHO LIVED IN A HOLE BY A
TREE ...

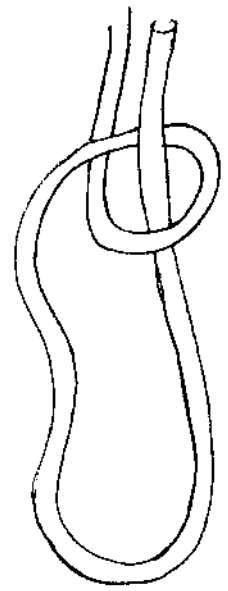

ONE DAY THE SNAKE
PUT HIS HEAD OUT
OF THE HOLE...

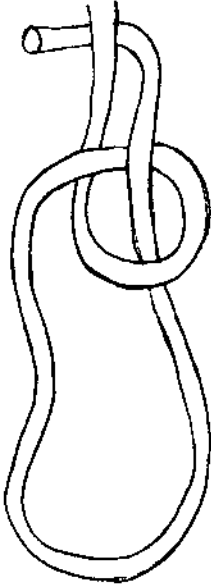

AND LOOKED ALL AROUND
THE TREE BUT HE SAW
NOTHING INTERESTING...

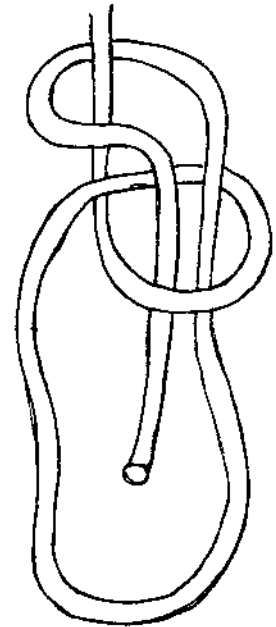

SO HE SLID BACK
DOWN INTO HIS HOLE

THE BOWLINE KNOT

■ 56 Tying a one-handed bowline

A

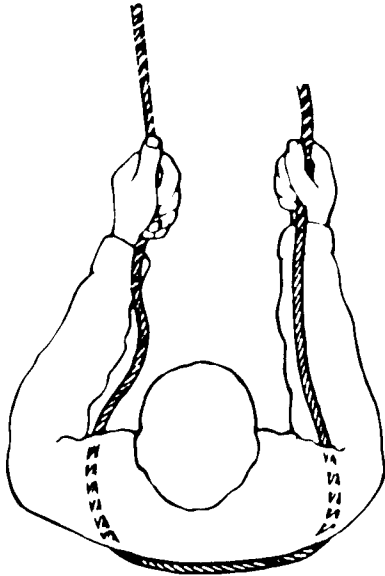

With your *left hand*, grasp the long end firmly to hold the tension

Pass the short end around you ■ 56A.

Take the tip of the short end in your *right hand* and bring it up to the slack portion of the line ■ 56B.

Grasp the slack and twist it into a loop so that the tip of the short end passes through it ■ 56C.

Pull a bit of line through the loop ■ 56D, then pass it underneath the slack ahead of the loop ■ 56E.

Pull the line back through the loop and tighten the knot ■ 56F.

B

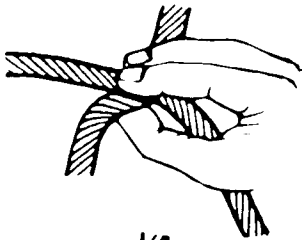

C

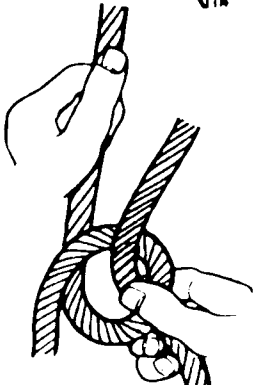

D

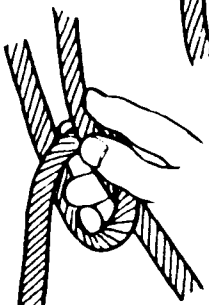

E

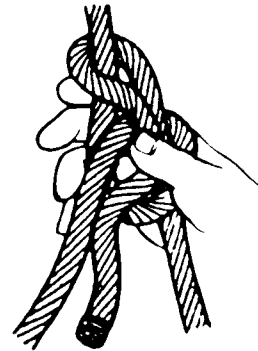

F

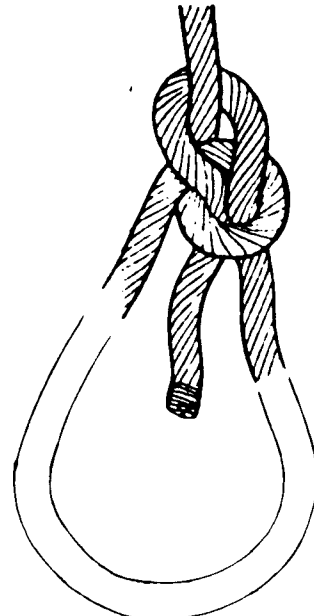

WARNING:

Do not use two bowlines to join lines together as this reduces their strength by about 50%.

Carrick bend ■ 212

To join heavy warps or lines of unequal size.

NOTE:

The ends can be tucked either over or under several times or bound to the line.

Sheet bend ■ 213

To join a line to a bight or two lines of unequal size.
When joining two lines an extra turn should be taken making the knot into a double sheet bend.

Stopper knot or rolling hitch ■ 214

To make a line fast to a shroud, stay or spar which will not slip when pulled in the opposite direction from the knot.

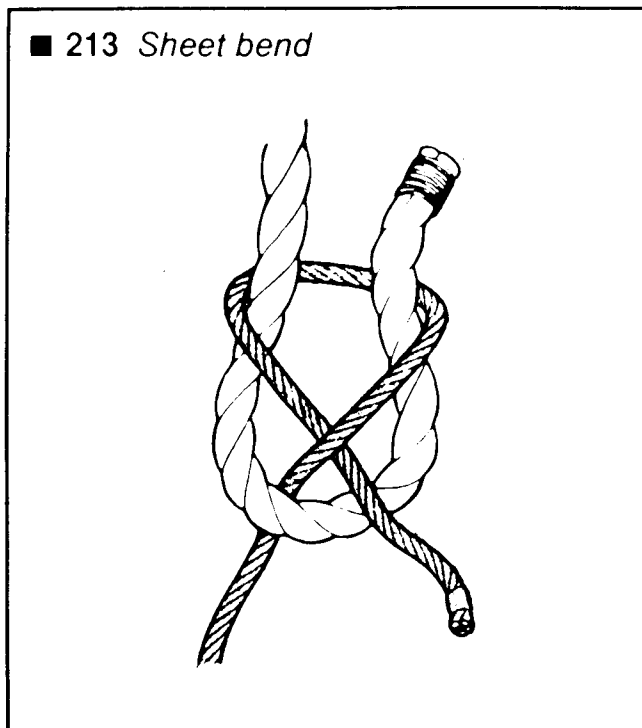
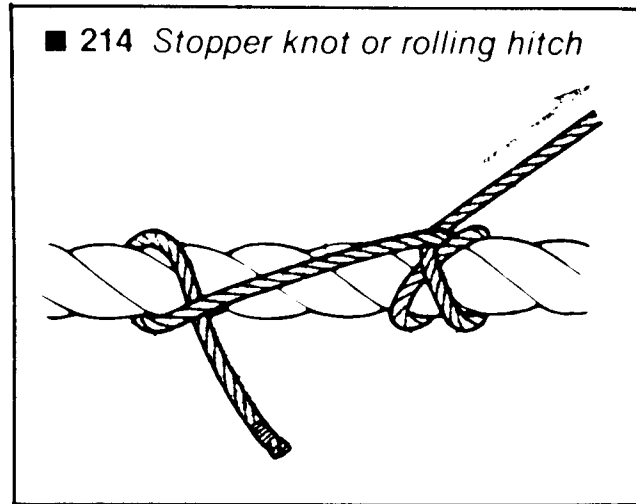
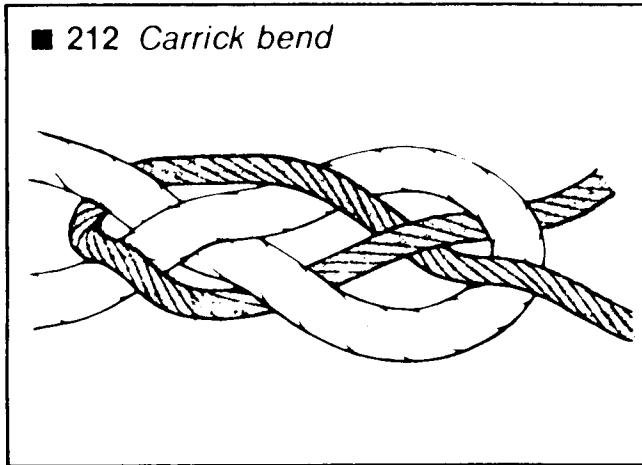

Tugboat hitch ■ 215

To attach a warp to a samson post or bollard.

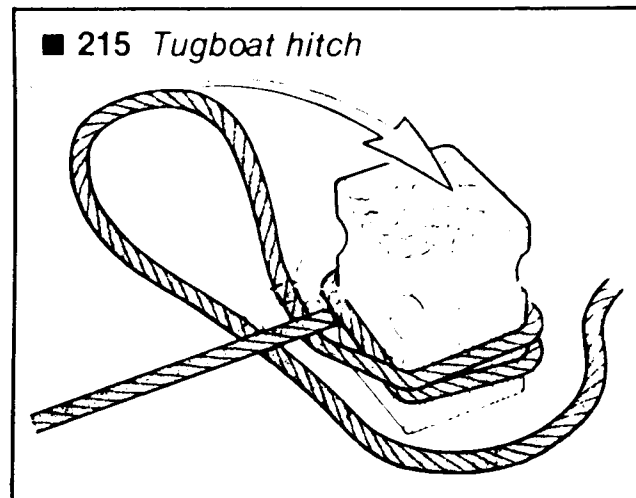

For lifelines or lashings with a pull in only one direction ■ 218



■ 218

MANHARNESS HITCH: A non-slip loop. It can be made along the length of the rope, but does not require access to an end. Several loops can be put on a rope for harnessing people together. Also a good way of preparing a rope for climbing. Toes and wrists can be put into the loops to carry weight allowing you to take a rest.

1 Make a loop in rope — look closely at the drawing.
2 Allow left side of rope to cross over loop. 3 Twist loop.
4 Pass it over left part of rope and through upper part of original loop. 5 Pull knot gently into shape, ease tight and test carefully.

Note: *If not eased tight correctly loop may slip.*

Different ways of making this knot may be found where the loop is not twisted at 3. The final strength of the loop does not appear to be affected either by making this twist or not, nor if the twist should straighten out in use.

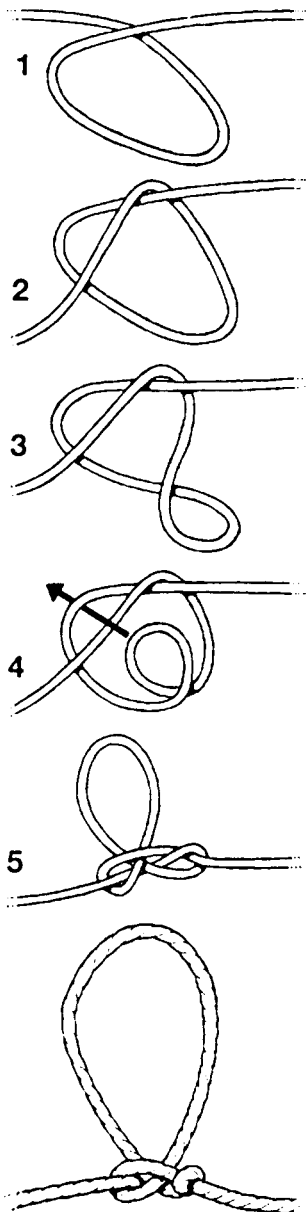

Ladders

Tie as many manharness hitches in a rope as you need hand and foot holds. Rungs may be added, using strong sticks or pieces of wreckage.

Use 2 ropes or a long rope, doubled, with manharness hitches placed equally along both sides to make a rope ladder. As you make loops, pass sticks through the corresponding loops and ease tight to hold sticks firmly. Allow sticks to project a few inches on either side of the ropes and test for strength.

LADDER OF KNOTS: A series of overhand knots tied at intervals along a smooth rope will make climbing it much easier.

1 Leaving a reasonably long free end, make a half-hitch near the end of a short piece of log. 2 Continue making loose half-hitches along the log — the diameter of which will fix the spacing of the knots. 3 Pass start end back through all the loops and then slide them all off the end of the log. 4 As each turn of rope comes through, the centre of the half-hitch loops to the other end. Shape and tighten each knot.

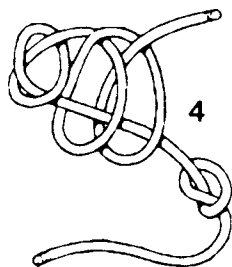
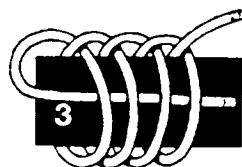
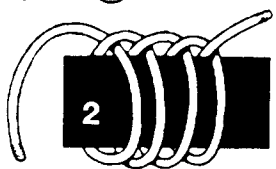
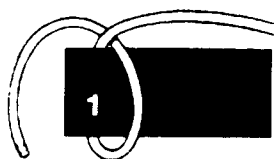
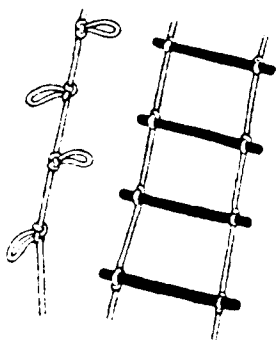

If no bosun's chair is on board, one may be improvised from:

- A tubular fender ■ 71.
- A boarding ladder ■ 72.
- A bowline on the bight ■ 73.

If no winch is available ■ 74

Attach one halyard to the bosun's chair.

Tie the end of a *second* halyard into a loop, which can be used as a stirrup.

While the climber supports himself on the stirrup, the bosun's chair is hoisted half a metre at a time.

Then climber transfers his weight to the chair, in order that the stirrup can be raised another half a metre.

NOTE:

This method is slow, safe, and requires little physical effort of the person on deck.

■ 74 Climbing the mast without a winch

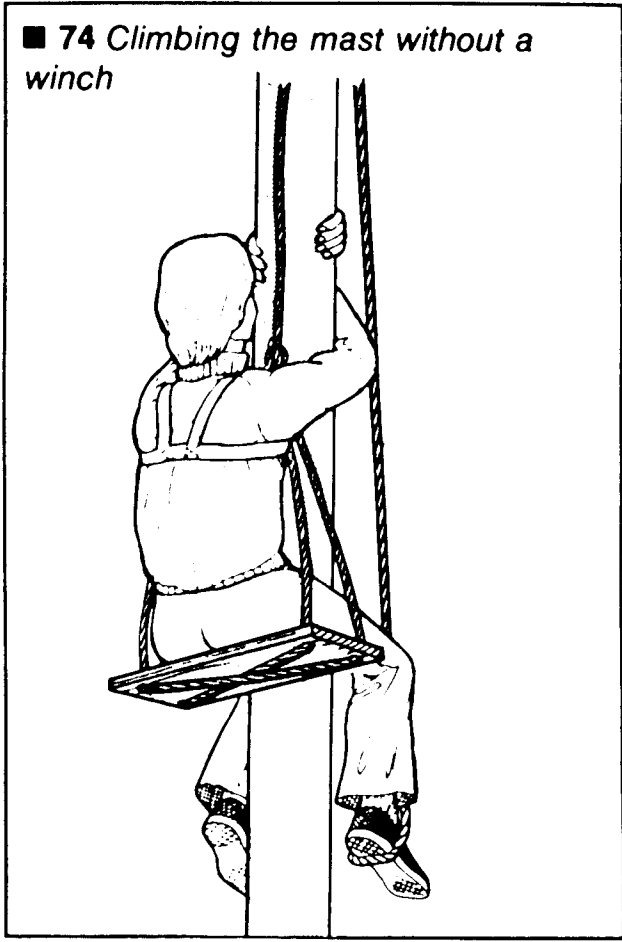

Emergency bosun's chair

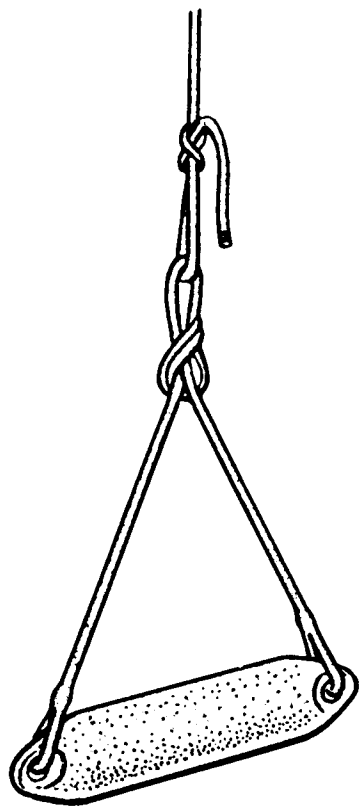

■ 71

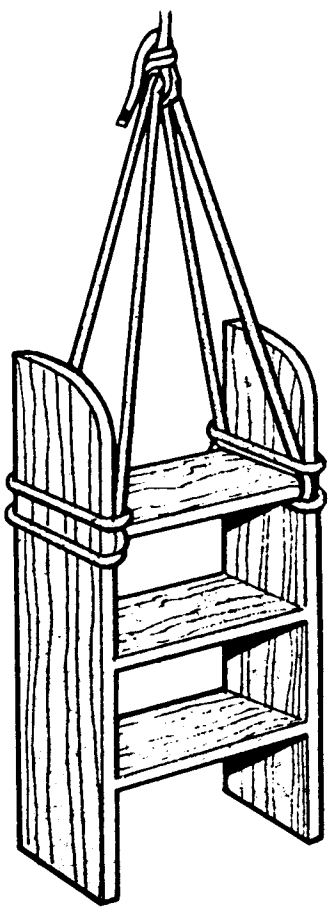

■ 72

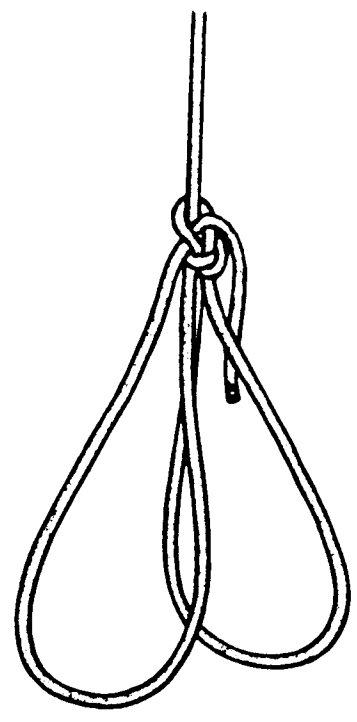

■ 73

METHOD 1 ■ 75, 76

Lay a length of stiff rope, such as a warp, on the deck, and at one foot intervals, tie large overhand knots to form stirrup-like bights.

Hoist the chain of loops aloft on a halyard, twist it several times around the mast to prevent it from swinging, then secure it tightly to a pin or cleat.

NOTE:

If the ladder is not long enough, the climber can secure himself to the cross-trees. The ladder can be unwound, hoisted to the masthead, then re-spiralled for the next stage of the climb.

METHOD 2 ■ 77

Lay a length of line on the deck – about three times the height of the ladder required – double it, then tie sheepshanks to form the steps.

Hoist the ladder aloft on a halyard and secure the end to the base of the mast.

■ 75, 76 A rope ladder from overhand knots

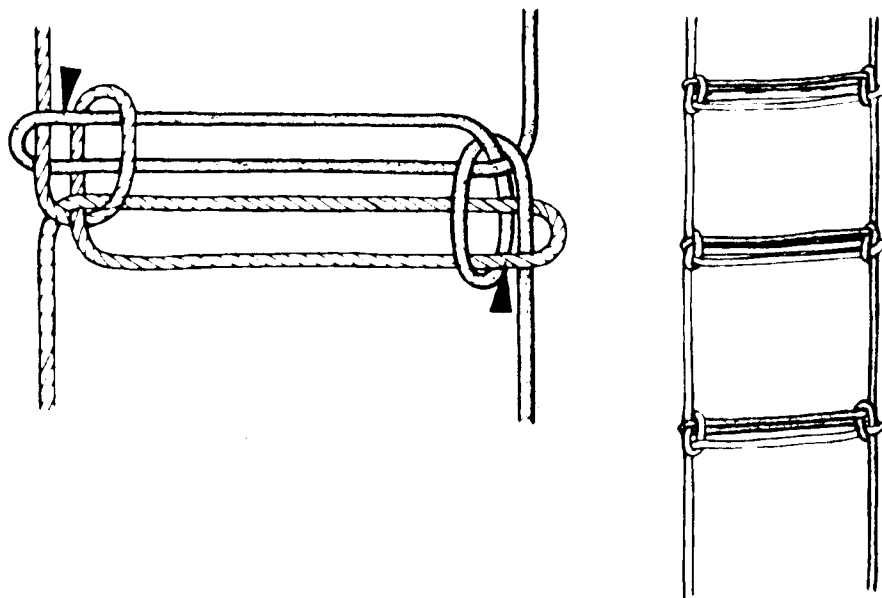
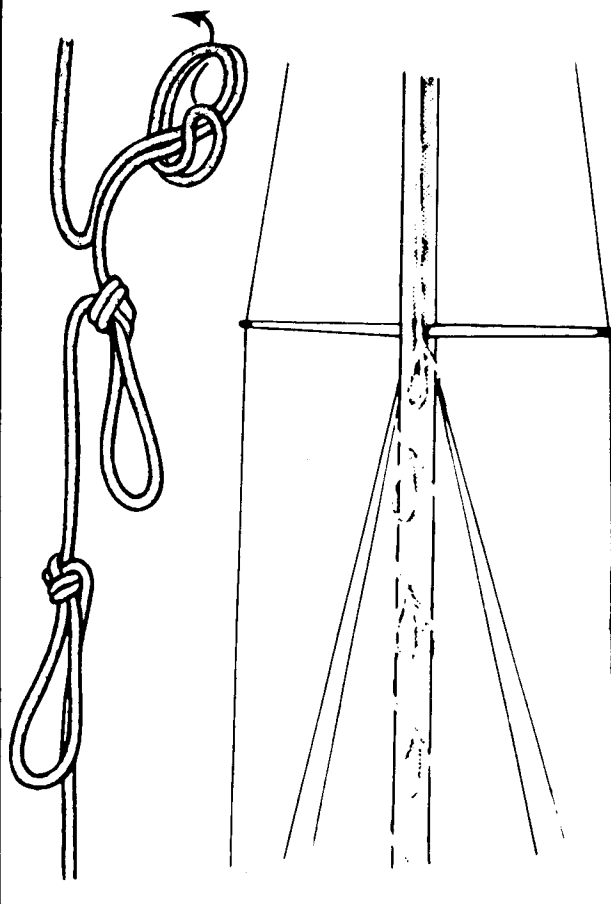

■ 77 A rope ladder from sheepshanks

METHOD 3 ■ 78

Using lengths of heavy cord, attach temporary ratlines to the shrouds with stopper knots (rolling hitches). **See:**

Knots

With a little practice, these knots can be tied with one hand, leaving the other free to hang on with. If the lengths of cord are pre-cut, they can be tied in place, one by one, as an ascent is made.

On an average-sized yacht, 8–12 lines should be enough to reach the cross-trees. Above that, if necessary, a web of ratlines can be tied between the upper shrouds, the mast and/or the forestay.

NOTE:

If the knots are being tied on stainless steel wire, a few turns of tape just below each knot will help it gain purchase.

METHOD 4 ■ 79

Short lengths of wood, for example cut from a boat hook, are tied with marlin spike hitches between two spare sheets to form a Jacob's ladder.

The ladder is tied to the main halyard, hoisted aloft, then cleated securely to the base of the mast.

METHOD 5 ■ 80

If the sail slides and their lashings are sufficiently strong, the mainsail can be slightly lowered and the slack in the sail used as ladder steps.

■ 78 *Ratlines*

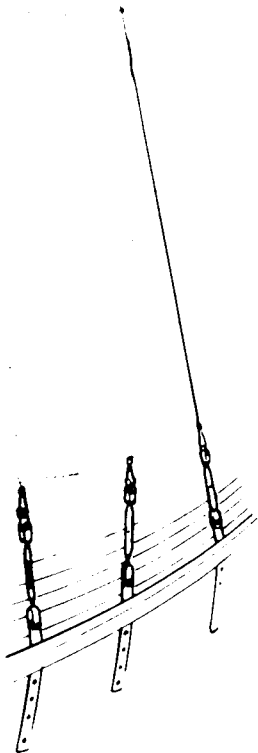

■ 79 *Jacob's ladder*

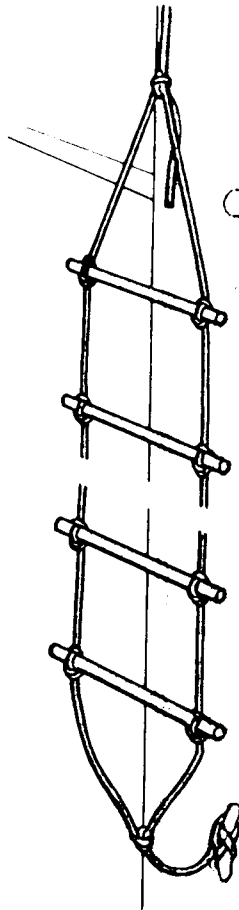

■ 80 *Climbing the sail*

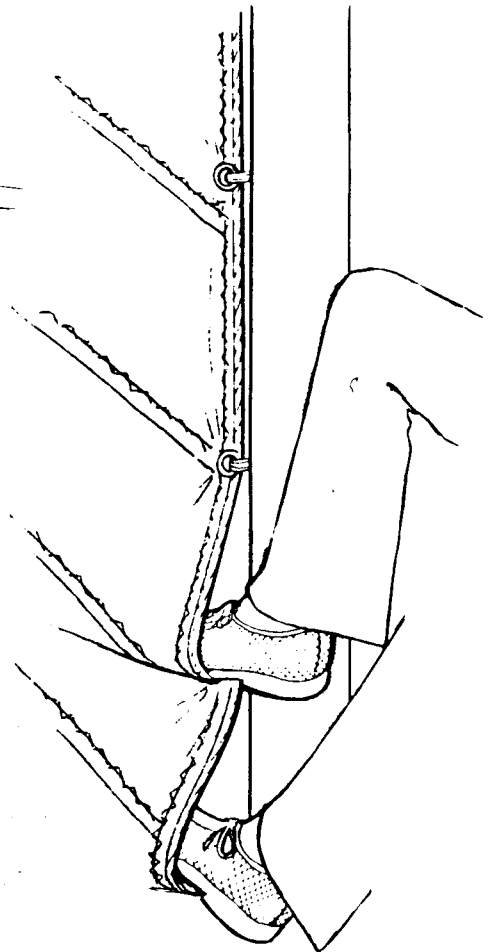

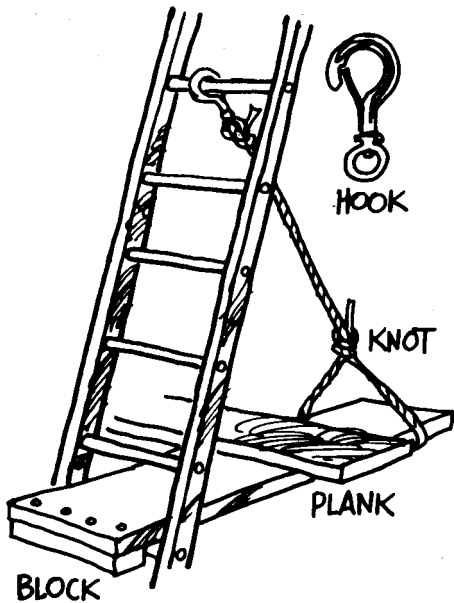

Everybody needs a good scaffold occasionally but nobody seems to know a handy way to put one together. Here, then—once and for all—is an extremely simple manner in which an ordinary ladder can be rigged to support one end of a plank. Set up a second ladder in the same way to hold the other end of the board and move the whole assembly as desired.

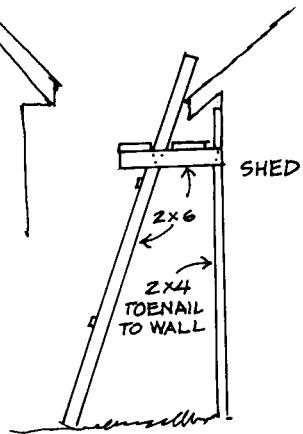
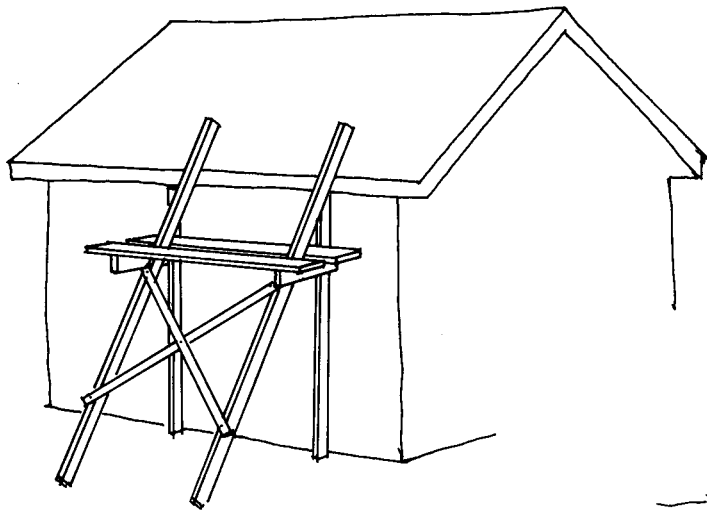

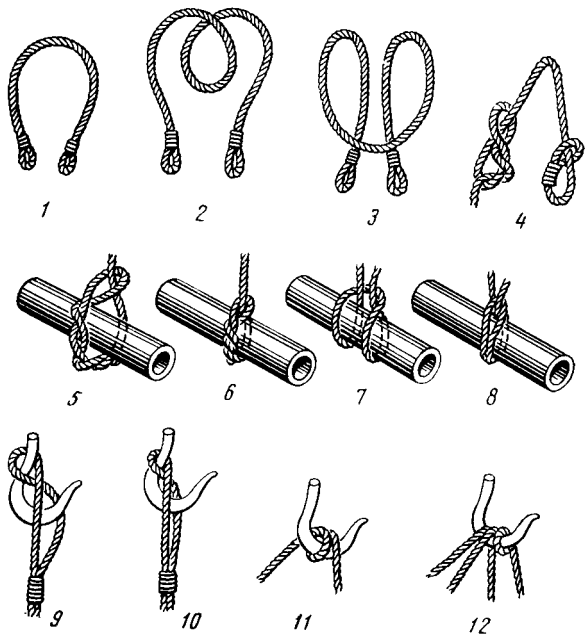
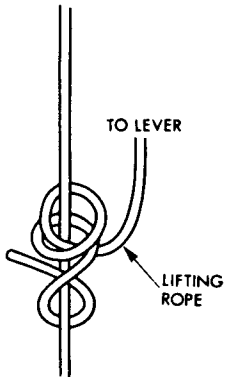

Fig. 230. Hoisting slings and knots

1, 2—sling with two loops; 3, 4—slings with one loop; 5, 6—timber hitch before and after tightening; 7, 8—clove hitch; 9, 10—blackwall hitch before and after tightening; 11, 12—tying slings with one and two lengths of rope to lifting hook

STEADY ROPE



ROLLING HITCH
CONSTRUCTION

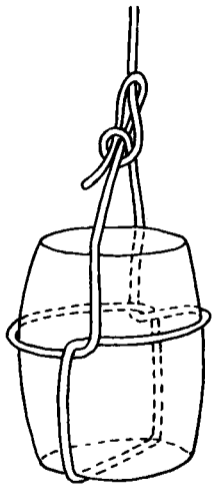

Tøndestik og Pølestik.

Fig. 40.

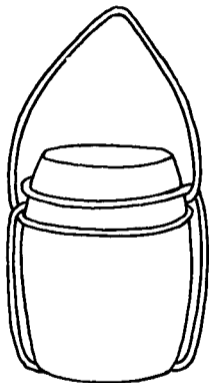

*Tøndestik med en
Strap eller en Bugt.*

Fig. 41.

A very useful variation of the figure eight knot is the *packer's knot*, which the man behind the counter uses to tie up your parcel. It is a slip knot which can be pulled tight and locked. A figure eight knot is made with the end around the standing part. Take care that this finishes with the end standing up, and not the other way. The line is tightened by pulling on the standing part, then a little loop, called a *half hitch*, is made with the standing part over the end projecting from the figure eight knot.

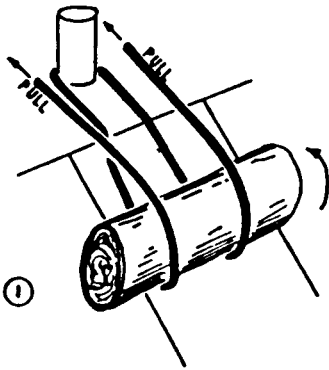

Parbuckling

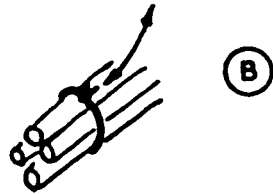

Packer's knot

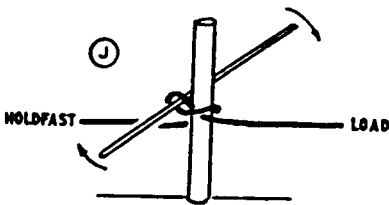

Spanish windlass

Weights are moved by tackle which gives the operator an advantage, but there are two simple ways of shifting weights which do not need special apparatus. An article which is round and can be rolled may be *parbuckled*. The center of the rope must be anchored to a holdfast, the two parts go under the object and the ends to the operator. Pulling on the ends gives him a two-fold advantage, except for slight frictional losses. A *Spanish windlass* may be used to shift a load horizontally. A rope from the load to a holdfast is looped with a short stick around a pole being held upright. If the stick is turned around the pole, considerable leverage can be applied.

HONDA KNOT: A free-running noose with a circular loop which is ideal for lassoing. If you have only one rope, don't use it as a lasso – this causes wear and damage to rope.

- a Start with an overhand knot.
- b Form a loop further down the rope.
- c Double rope into a bight between loop and knot.
- d Pass bight through loop.
- e Tighten loop round bight.
- f Pass long end of rope through new eye formed by bight.

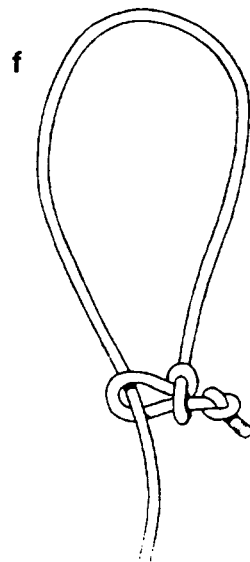
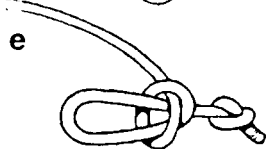
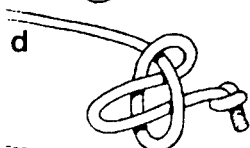
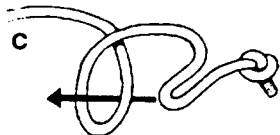
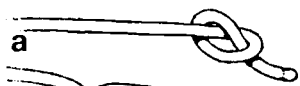

Before lassoing an animal, consider its strength. A big animal may wrench the rope away, depriving you of a meal and a rope. If the rope is anchored to you, you may be dragged along and injured. Instead, use a firm anchor – a tree or rock – to take the strain.

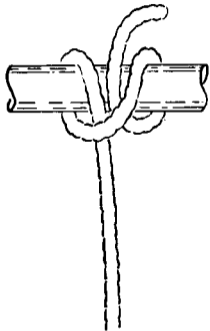

Dobbelt halvstik
omkr. rør ell. lign.

Fig. 15.

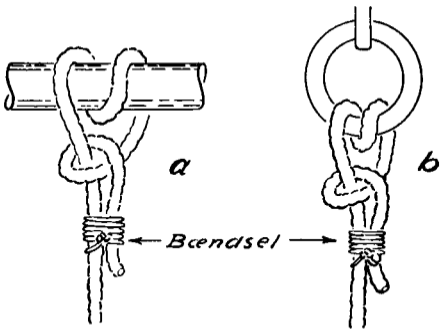

Rundtørn om fast konstruktion og
derefter enkelt halvstik med bændsel.

Fig. 16.

Hitches

Use to attach ropes to posts, bars and poles.

ROUND TURN AND TWO HALF-HITCHES: The best way to secure a rope to a post. Can take strain from any direction. Carry rope behind post, then round again. Bring live end over and back under standing end and through loop thus formed. Tighten and repeat half-hitch to make knot secure.

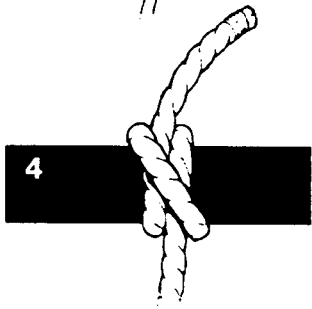
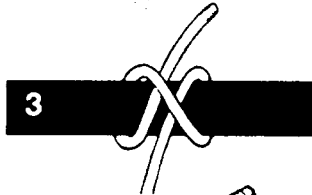
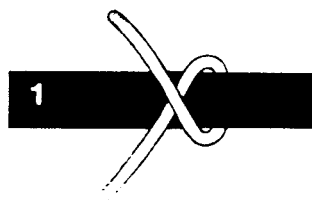
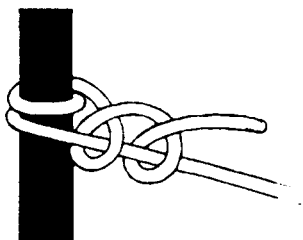

CLOVE HITCH: Effective when strain is perpendicular to the horizontal. Not so good when the strain comes at an angle or is erratic.

1 Pass live end over and round bar. 2 Bring it across itself and round the bar again. 3 Carry the live end up and under itself, moving in the opposite direction to standing end. 4 Close up and pull tight.

TIMBER HITCH: Use as a start knot for lashings and for hoisting and for dragging or towing heavy logs.

1 Bring live end round bar and loosely round standing end.

2 Carry forward and tuck beneath rope encircling bar. Twist round as many times as comfortably fit.

Tighten knot by gently pulling on standing end until a firm grip is achieved.

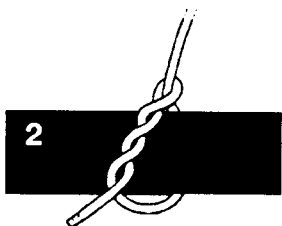

KILLICK HITCH: To secure a line to an anchoring weight, make a timber hitch round one end of weight and tighten. Carry line along weight and make a half-hitch.

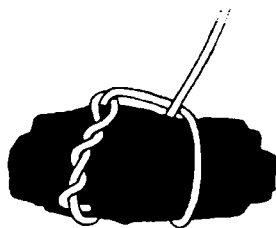

MARLIN SPIKE HITCH: A temporary knot for securing a mooring line to a post, or for dragging over the top of an upright peg. By attaching a short, stout stick to the line it is possible to gain extra purchase for a firmer pull.

1 Form a loop in the rope - study drawing carefully. 2 Bring one side of loop back up over standing end. 3 Drop this over the pole - the pole coming between extended loop and standing part. Pull live end to tighten.

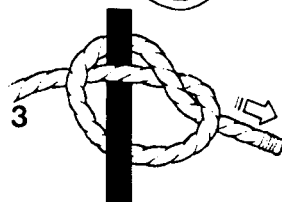

QUICK-RELEASE KNOT: A secure knot, but will come untied with a single sharp tug on the live end. Recommended for temporarily anchoring lines.

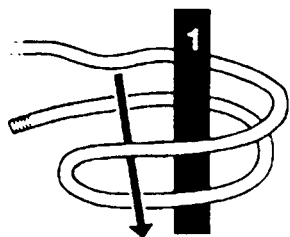

1 Carry a bight round a post or rail.

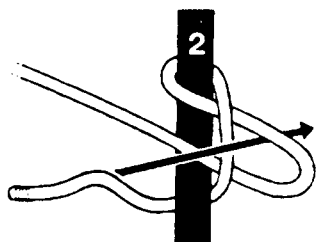

2 Bring a bight from the standing end through the first bight.

3 Form live end into a further bight and push doubled end through loop of second bight.

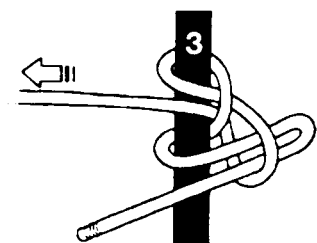

4 Pull on standing end to tighten knot.

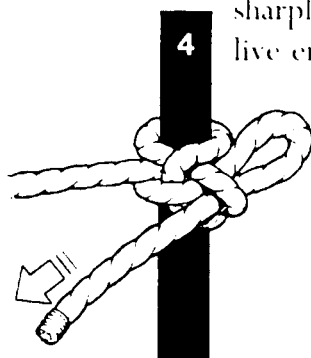

4 To release pull sharply on live end.

Shortening rope

SHEEPSHANK:

Treble the line.

Form half-hitches

in outer lengths and slip over adjoining bends. Or, instead of half-hitches, when a loop is formed in the standing part, pull a bight through it and slip this over bend in rope. Tighten as you gradually increase tension.

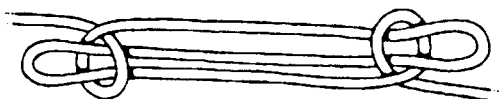

Make a sheep-shank more secure by passing a stick through the bend and behind the standing part (a).

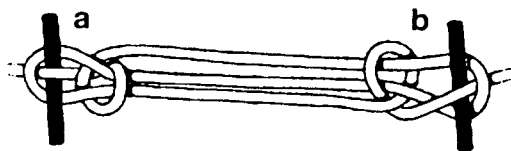

Or, if you have access to the rope's end, pass that through the bight (b). A stick would make this more secure.

Never cut a rope unnecessarily: a joined rope has only half the strength of a continuous one. Use sheepshank to shorten it or to exclude a damaged section.

Securing loads

WAKOS TRANSPORT KNOT: Use to secure a high load or to tie down a roof. For maximum purchase, pull down with all your weight then secure with 2 half-hitches. If it comes loose, undo the hitches, retighten and secure.

1 Make a loop in rope. Further down, towards end of rope, make a bight. 2 Pass bight through loop. 3 Make a twist in the new lower loop. Pass end of rope round securing point and up through this twist. 4 Pull end to tighten. 5 With end make two half-hitches round lower ropes to secure. Undo these to adjust and retighten.

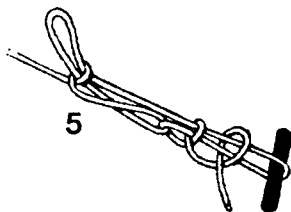
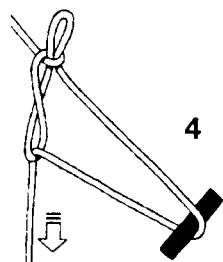
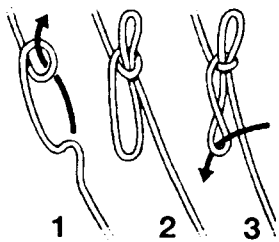

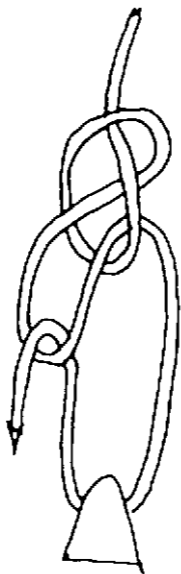

The trucker's hitch, a useful hitch for tightening down a lashing.

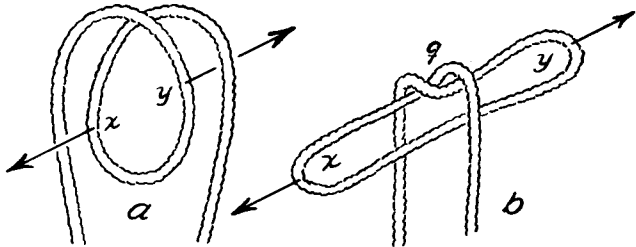

Fig. 43.

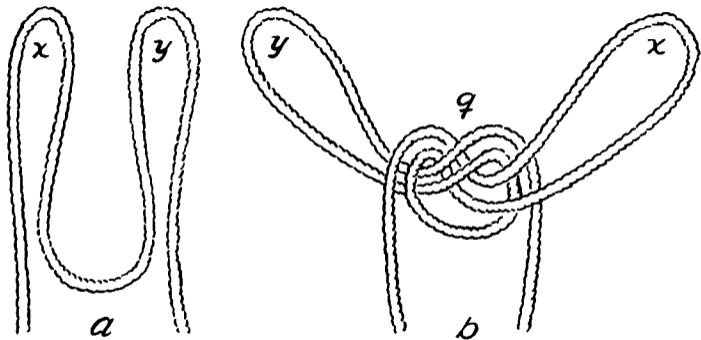

Fig. 44.

PRUSIK KNOT: A sliding loop. It will not slip under tension, but will slide along when tension is released. A pair of prusiks provide hand and foot holds for climbing or for swinging along a horizontal line. Slide them along main rope as you proceed. Also good for tent guylines.

1 Pass a bight round main rope, pull ends through. Keep loose.

2 Take ends over again and back down through loop. Ease tight. Do not allow circuits to overlap.

3 This gives the appearance of four turns on the main rope (a).

Mountaineers take ends round and back through loop to give the appearance of six turns on main rope (b).

4 A prusik knot can be made using a fixed spliced loop: pass bight over main rope and back through itself, and repeat.

5 For use as a tensioning line attach along the guy rope etc., and secure ends (a) to an anchor.

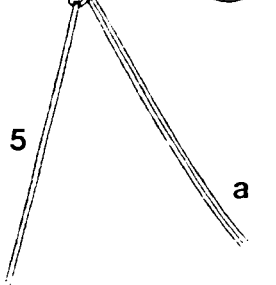
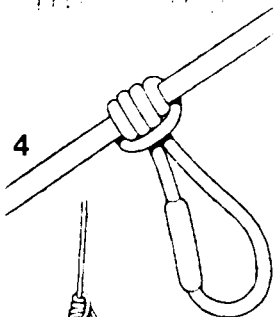
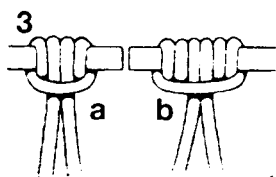
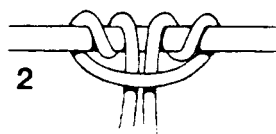
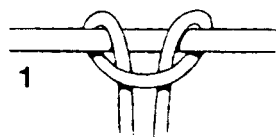

When used for climbing, or travelling along a rope, a spliced loop (4) is safest. If you have no spliced loop, join ends after knot is made. Test joins rigorously before use.

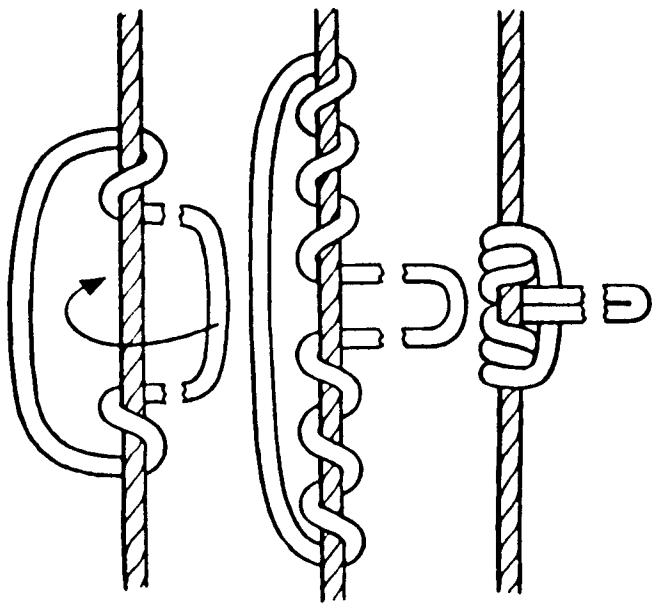

Fig. 4.8. The Prusik Knot.

Prusik Knot. The Prusik knot is a valuable means of saving yourself if you fall into a crevasse, or in climbing up a rock face. The knot will hold tightly when weight is applied, but it will slide easily when unweighted. The method of tying is shown in Fig. 4-8. Take a bight of line and turn it twice around the rope, then pull the loose ends of the line through the loop.

You can also use the Prusik knot for climbing a rope. Use three slings fashioned from lengths of line. Make two stirrups and a chest loop fastened by Prusik knots to the climbing rope, as in Fig. 4-9. There should be about five feet between the stirrup and the knot in order to have the knot in front of the chest in an easy handling position. Then, by moving first one stirrup and then the other, it is possible to climb the rope. At the same time, by pushing up the chest loop, the victim is secured against loss of balance and can take a rest by leaning back at any time.

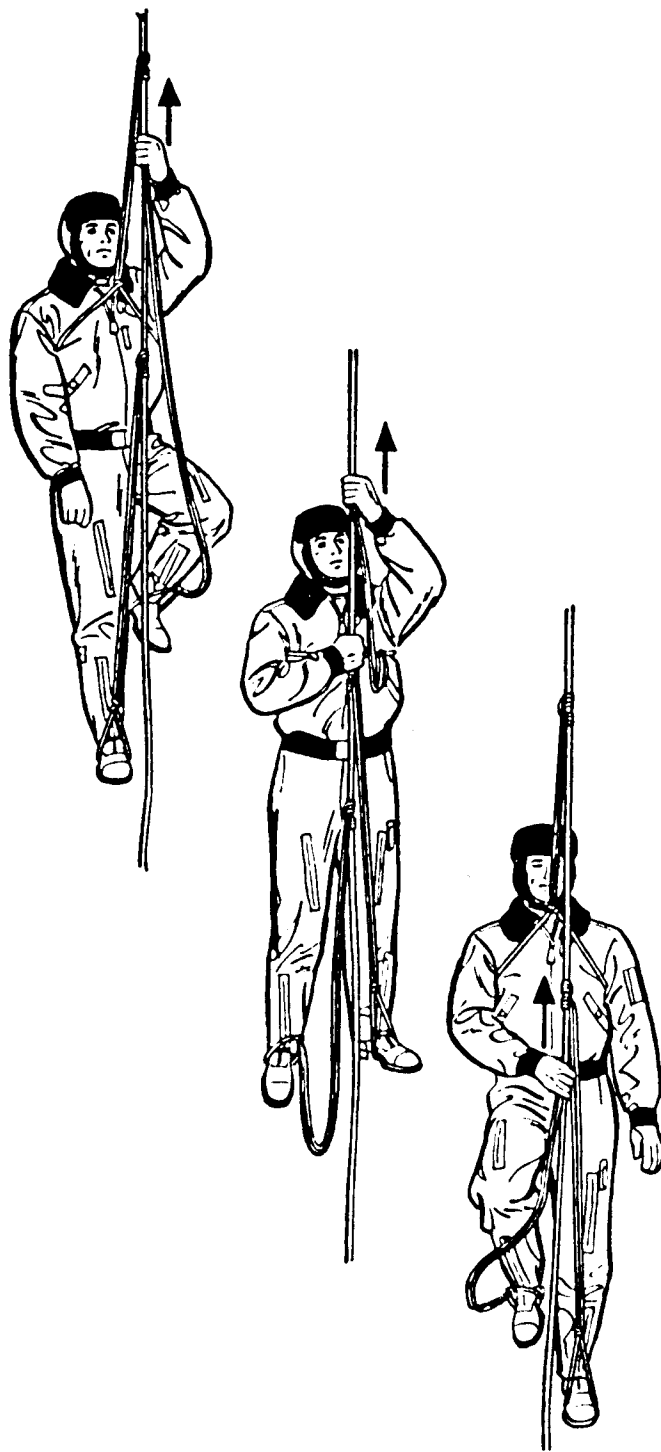
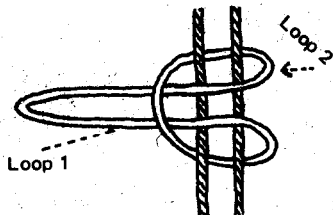

Fig. 4.9. Use of Prusik Knot to Climb a Rope.



It's best to take loop one around again and come through loop two again—for double protection. This knot will slide when no pressure (weight) is placed on it, but will tighten, and hold you as soon as you put your weight on it.

Carabinier with safety lock:



Harness: You can buy a ready-made harness or make one out of about two yards of nylon strap from a mountain climbing shop. The ends are tied to make a continuous loop. To get into it, hold the entire loop horizontally behind your ass and bring the loop ends together in front of your crotch. Hold them with one hand and reach back between your legs with your other hand to grab the lower line. Pull this line between your legs to meet with the other loops in front. Hook the carabinier through all three loops and wiggle the whole business up to waist level.

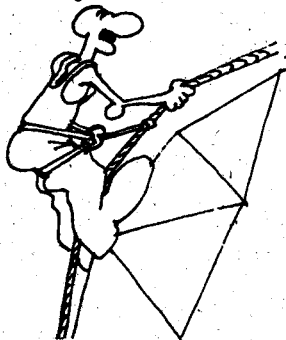

When you lean back, the knot holds. To move, you take weight off the knot. When you get to desired position, lean back, and you can work with both hands free. It's a strange sensation—you'll gradually learn to trust the rig. It works best to start at top, and work your way down: you get so you learn the amount of relief needed to descend, and soon you're walking up and down on the domeskin. Have care not to slip feet up-head down; you'll fall out of the harness.

Lashing Together Two Poles

1. Start with a clove hitch.
2. Loop the rope over and under the poles twice.
3. Loop the rope under and over the poles twice.
4. Tighten the loops by wrapping the rope around the midsection several times, as shown in the illustration. Finish with a clove hitch.

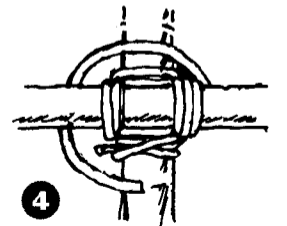
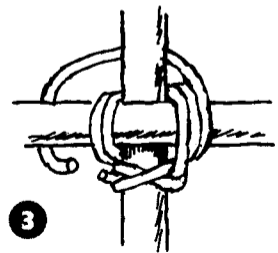
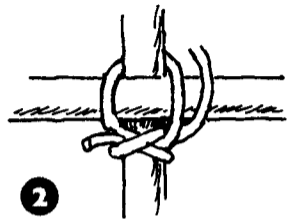
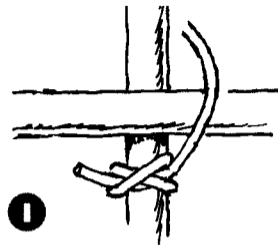

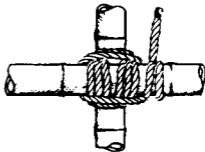
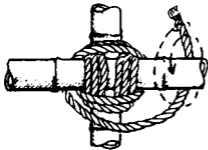
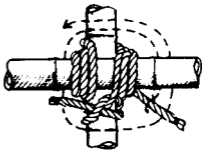
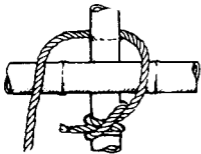

Lashings

Methods of lashing differ according to the position of the components. These techniques are invaluable in making rafts, shelters, etc.

SQUARE LASHING: For lashing spars which cross at right angles. 1 Make a timber hitch carrying line alternately above and below both spars in a complete circuit before securing it. Then carry rope anti-clockwise over and under both spars. 2 After three or four circuits make a full turn round a spar and circuit in the opposite direction. 3 Complete circuits with a half-hitch round one spar and secure with a clove hitch on a spar at right-angles.

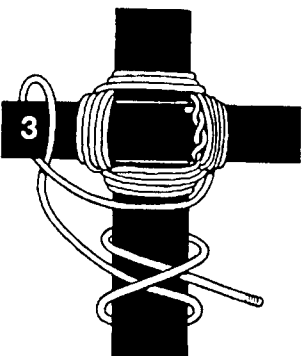
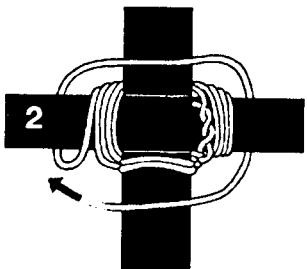
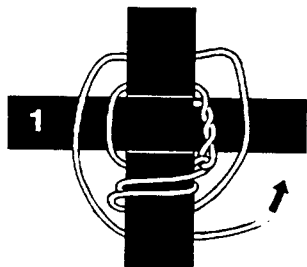

ROUND LASHING: Use to lash spars alongside each other or to extend length of a spar.

Begin with a clove hitch

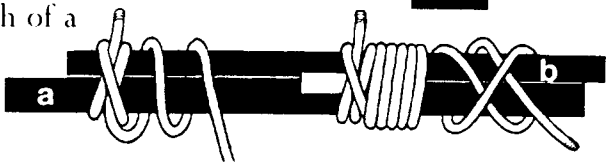

round both spars (a), then bind rope round them. Finish knot with a clove hitch at other end (b). Force a wedge under lashings to make them really tight. If spars are vertical bang the wedge in downwards.

DIAGONAL LASHING: Use when spars do not cross at right-angles, or when spars need to be pulled towards one another for tying.

1 Begin with a timber hitch round both spars, placed diagonally.

2 Frap (lash) both spars with a few turns of rope over a timber hitch, then make a full turn under the bottom spar.

3 Frap across other diagonal, then bring rope back over one spar and make two or three circuits above upper spar and below lower. 4 Finish with a clove hitch on a convenient spar.

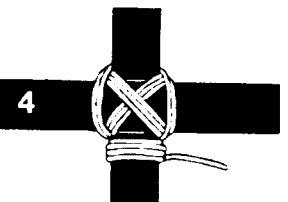

SHEAR LASHING: To tie ends of two spars at an angle, e.g. for an A-frame. Begin with a clove hitch

(a) round one spar. Bind, not very tightly, round both. Bring rope between spars and frap a few times round binding. Finish with a clove hitch round other spar (b). Tighten by opening up shears (c). A similar method can be used round three poles to make a tripod. Make turns round all three legs and frappings in the two gaps.

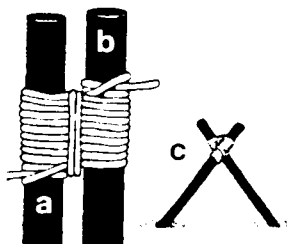

The feet of A-frames and tripods should be anchored to stop them spreading.

Lashing two spars together ■ 219, 220

Begin with a clove hitch.

Tuck the short end under the long one as you make the first turn.

Make at least two complete turns, pulling the line taut after each one.

End with a clove hitch or two half-hitches.

NOTE:

Whether lashing two spars together or at right angles to each other, the method is the same.

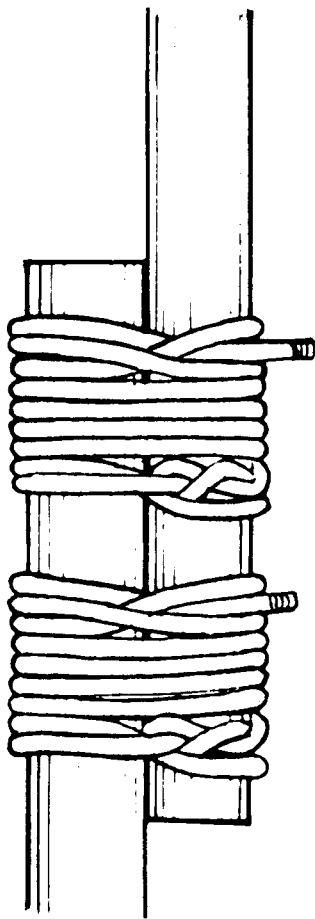

■ 219

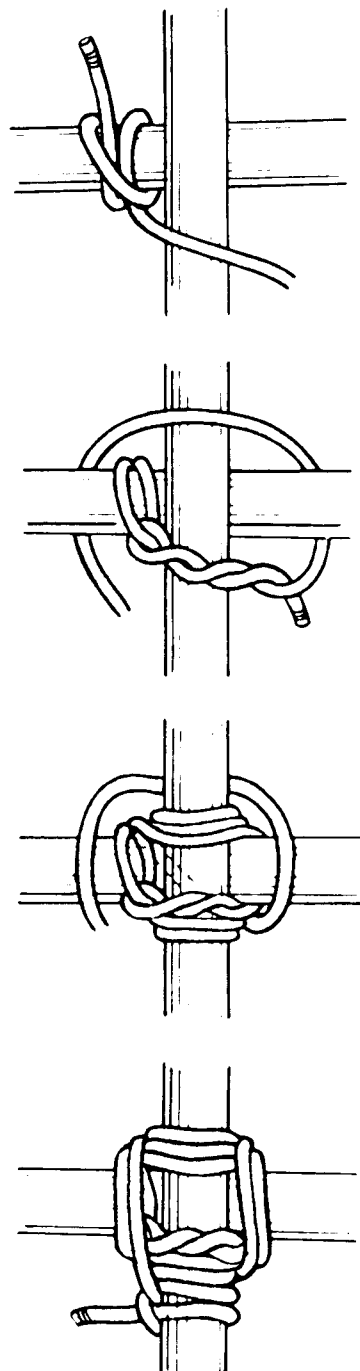

■ 220

18 A guide to anchorages

Anchorage are needed in a variety of situations – for example, bridging, lifting, vehicle recovery, and stabilizing sheer legs and structures. The following is a guide to anchorages which can be improvised in the field.

Natural or structural anchorages

A tree can be strengthened as an anchorage by tying it back to another tree or to a picket holdfast. Two trees close together can be used with a stout timber log between them to spread the load. Always try to spread loads taken on stone masonry and brickwork. The pull should be taken as close to the ground as possible.

Picket holdfasts

A picket is a stout pole up to about 1.5m long. One end is pointed for driving into the ground. Pickets are used singly or in groups lashed together. Various combinations are shown in Figure A18.1.

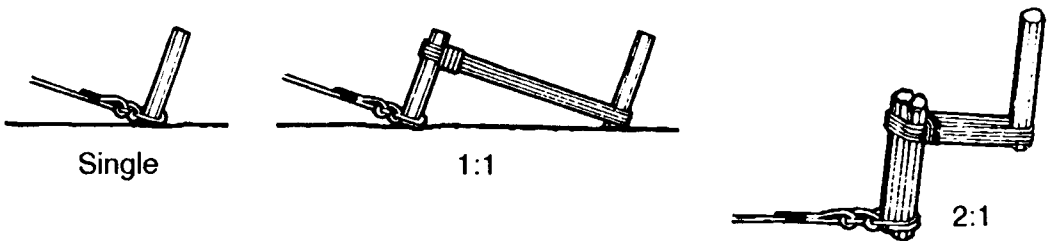

Figure A18.1 Combinations of picket holdfasts

Key points when using picket holdfasts in normal ground:

- pickets should be driven at least a metre into the ground at right-angles to the line of pull
- the lashings connecting the pickets should be at right-angles to the pickets
- lashings should come from the head of the picket in front to the bottom of the back-up picket
- there should be no slack in the lashings.

Holdfasts can be used in rock by chiselling holes with a 'jumper bar' and jamming steel crowbars or angle iron into the holes. Wire ties can be used for back-up lashings.

Withdraw pickets in the same line as they were driven in or they may break.

Baulk anchorage

This anchorage uses a log or stout timber (a baulk), held by a series of picket holdfasts (Figure A18.2). Use for loads of 2 to 10 tonnes.

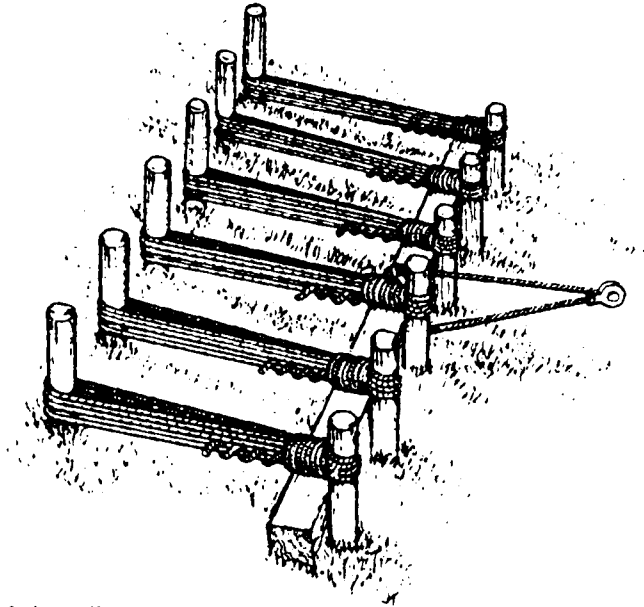

Figure A18.2 A baulk anchorage

Key points when using a baulk anchorage:

- there should be the same number of holdfasts either side of the pull
- holdfasts should not be less than 0.5 metres apart
- the log must bear evenly on all the pickets
- the log should rest on the ground and soil removed for the rope to pass around the log
- square section timber must be bedded into the ground so that a flat face bears evenly on all pickets.

Buried log anchorage

A buried log anchorage is used for pulls above about 10 tonnes. A log, or several logs, are buried horizontally in a trench (Figure A18.3).

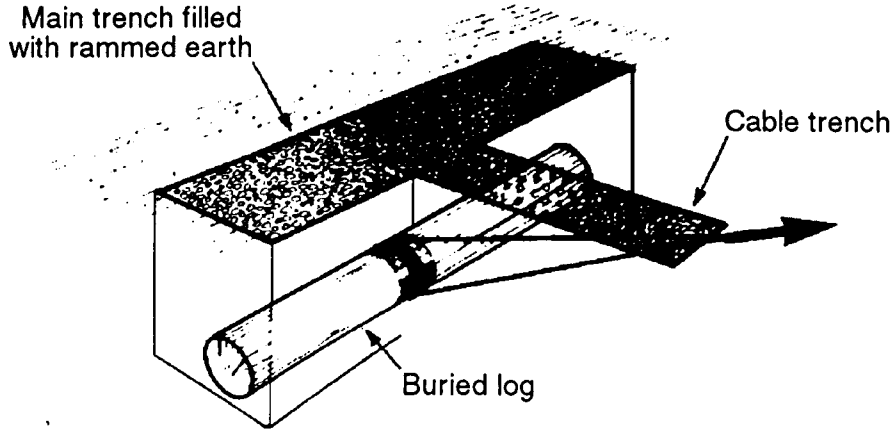

Figure A18.3 A buried log anchorage

Key points when using a buried log anchorage:

- the log, timber or steel pipe must be chosen to resist failure due to shear or bending
- the trench is dug with a vertical face at right-angles, in the horizontal plane, to the direction of pull
- the optimum burial depth is half the length of the log
- the trench for the cable is dug as narrow as possible
- the main trench is filled and rammed with earth; the cable trench is left open for the inspection and adjustment of cable and fastenings.

(Adapted from MoD, 1981a)

19 A guide to sheers and gyns

Sheers

A sheer is a hoisting apparatus of two poles or spars tied together at the top and with the feet separated. To assemble the sheer, the spars are laid on the ground and the bark stripped away at the point of the lashing. Lash the spars together while they are side-by-side so that when they are opened out the lashing will be tight. If the spars are large they may need to be opened some distance before lashing. A typical arrangement is shown in Figure A19.1. Note that the guy ropes are arranged so that they draw the spars together when loaded. The load sling is passed over the fork formed by the spars.

Sheers can be used to move a load in a straight line swung between the legs until the sheers lean at a limiting slope of 3:1. In this case the base of the spars must be well anchored.

General rules for loads:

- sheer legs made of 4in. spars are suitable for lifting up to 4 tonnes
- sheer legs made of 6in. spars are suitable for lifting up to 10 tonnes

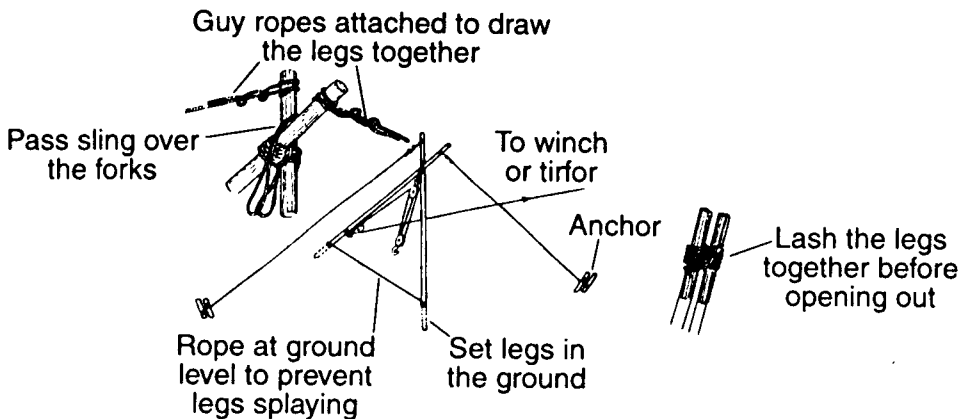

Figure A19.1 Sheers

Gyns

A gyn is shown in Figure A19.2. Gyns can only be used to lift vertically or to support a vertical load. A gyn occupies little space and no guys are required. To erect the gyn, lay two spars in one direction and the middle spar in the other direction as shown in Figure A19.2. Lash the three spars together before crossing the two outer spars until the feet of the spars are a distance apart of about half the length of the spars. Lash poles between the feet of the spars to fix their distance apart. Place the load sling across the top lashing and lift the spars. Push the middle spar into the triangle formed by the other two spars and the bottom pole until an equilateral triangle is formed on the ground by the feet of the spars. The top lashing can be

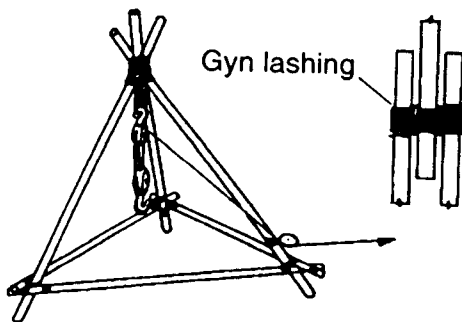
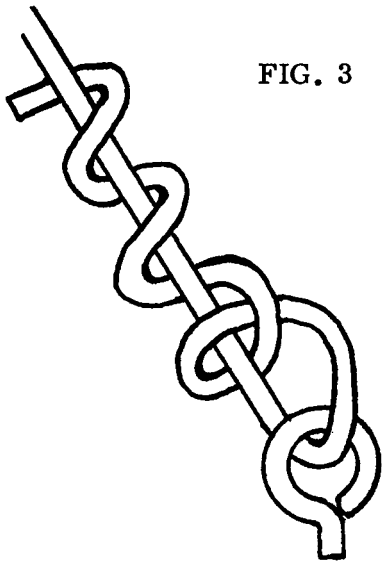

Figure A19.2 Gyn

prevented from slipping during lifting by a nail driven into the middle spar just below the lashing. Anchor the feet of each spar to prevent movement when loaded. The head of the gyn should be placed above the load to be lifted. Guy ropes should be fixed if there is a chance of a load moving sideways.

(Adapted from MoD, 1981a)

FIG. 3



Guy wires should be tied

The sketches below show the lashing techniques for both gable and hipped roof structures. They are both 12'-6" long, 10'-3" wide, 8'-6" high. The lashing material was generally a three-ply braid of 'uki'uki grass. "They make little use of these dwellings, except to protect their food and clothing," wrote a member of Cook's expedition in describing the small (4'-6' high) houses of Hawaii, "and most generally eat, sleep and live in the open air, under the shade of a *kou*, or breadfruit tree."

THE GABLE

1. CORNER POST
2. SIDE POSTS
3. WALL PLATE
4. RIDGE POST
5. MAIN RIDGE
6. RAFTERS
7. GABLE RAFTER
8. 2ND RIDGE
9. GABLE POSTS
10. GABLE PLATE

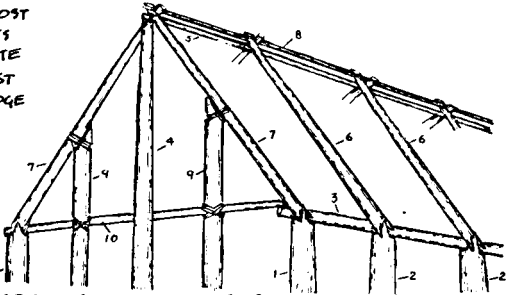

FRAME OF GABLE END HOUSE

SIDE POSTS WERE ABOUT 4' HIGH AND 6"-8" IN DIAMETER. POSTS WERE HARDWOOD (UHIHI, NAIO, PUA, OTHERS). SET POSTS IN HOLES, MAKE FIRM WITH STONES.

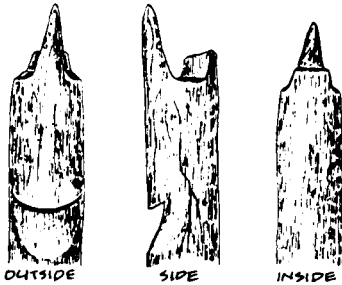

TOP OF WALL POSTS

LASHING WAS DONE WITH A 3-PLY BRAID OF 'UKI'UKI GRASS. COCONUT FIBER WAS RARELY USED.

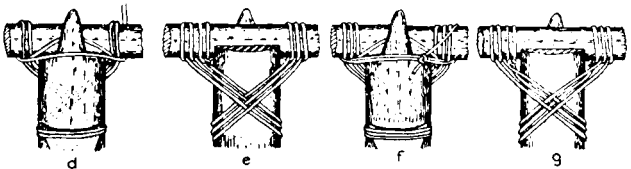
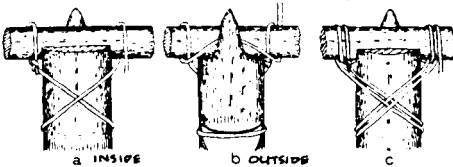

LASHING WALL PLATE TO WALL POST

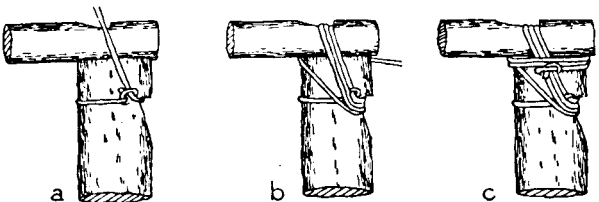

RIDGEPOLE TO RIDGEPOST

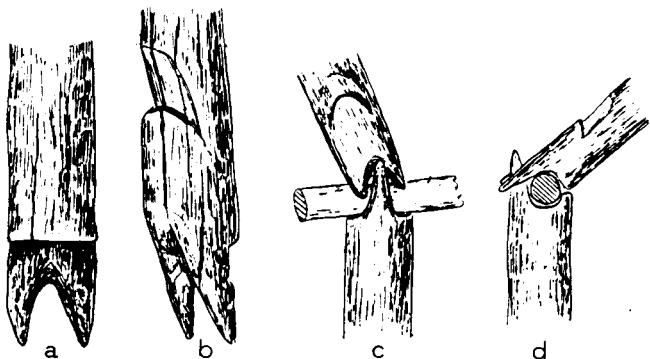

RAFTER END
 LOWER RAFTER END, AT POST AND WALL PLATE

POST, WALL PLATE, RAFTER
 AT POST AND WALL PLATE

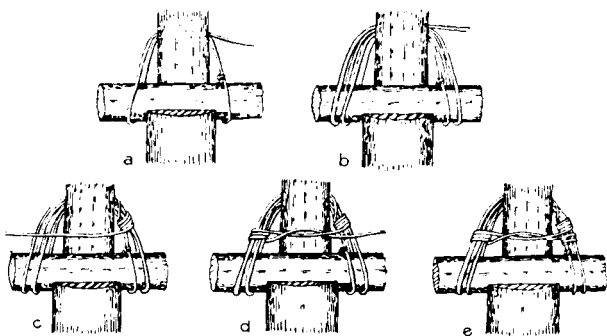

LASHING RAFTER TO WALL PLATE
 AT (d), PULL TAUT BEFORE KNOTTING (e)

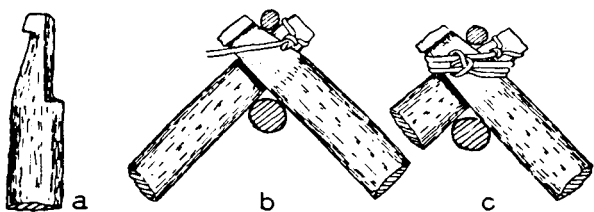

LASHING RAFTERS AT RIDGE

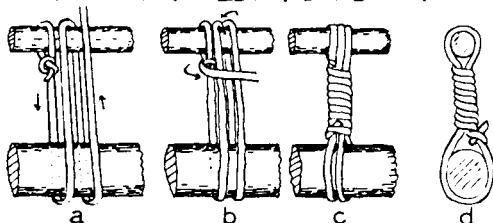

LASHING RIDGEPOLES TOGETHER

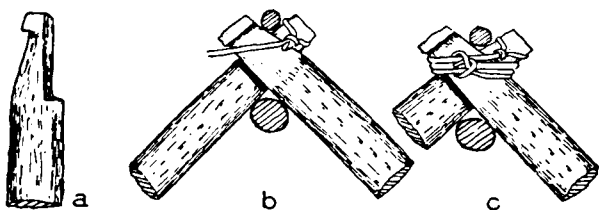

LASHING RAFTERS AT RIDGE

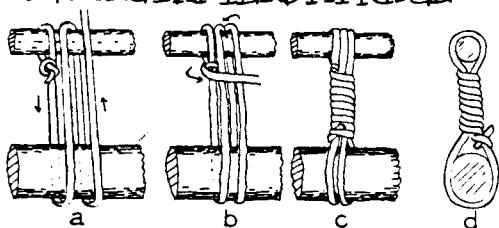

LASHING RIDGETEAMS TOGETHER

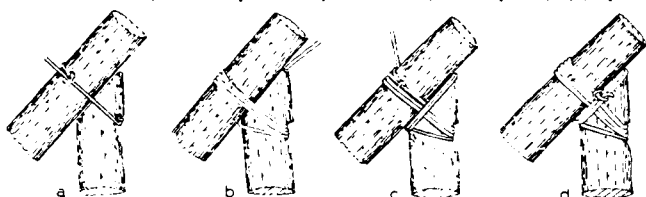

LASHING CABLE POSTS TO CABLE RAFTERS

NOW BASIC FRAME IS COMPLETED. THE PURLINS ARE ADDED TO THE FRAME TO ATTACH THE THATCHING. SEE THE DRAWINGS AT THE ABOVE RIGHT FOR LOCATION OF PURLINS.

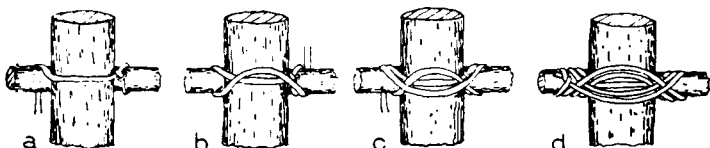

LASHING MAIN PURLINS TO RAFTERS AND POSTS
ORNAMENTAL LASHING VIEWED FROM INSIDE.

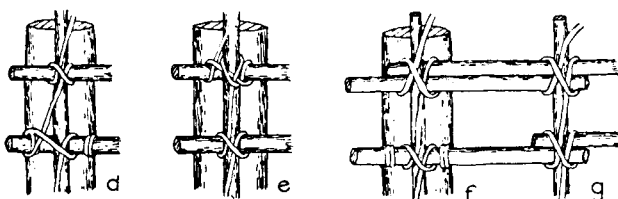
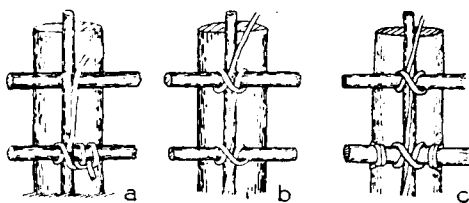

LASHING PURLINS TO SUPPORTING ROD

Lashing purlins to supporting rod: main purlins $\frac{3}{4}$ -1" thick; thatch purlins, $\frac{1}{2}$ - $\frac{3}{4}$ " thick go between main purlins on both roof and wall. They are not lashed directly to rafters or posts but to $\frac{1}{2}$ " vertical rods.

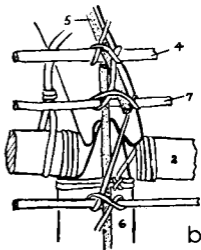
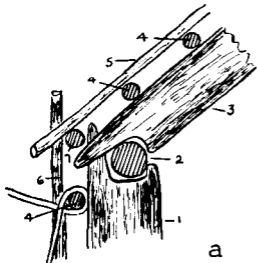

Junction of roof and wall rods: a, side view of junction between roof rod (5) and wall rod (6) with extra purlin (7); b, continuation of clove-hitch lashing down over extra purlin (7); c, close-up of junction join with wall rod (6) on right; d, junction join with wall rod (6) on left.

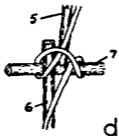
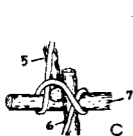

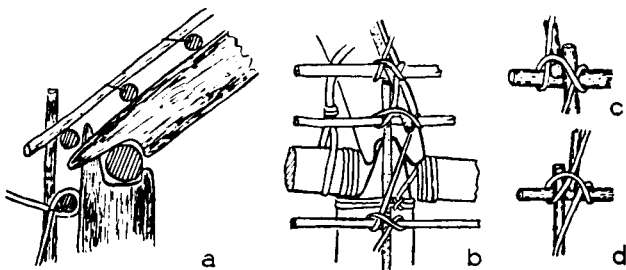

JUNCTION OF ROOF AND WALL RODS

HAWAIIAN NAMES: *

POU KIHU : CORNER POSTS

POU KUA : WALL POSTS, BACK

POU ALO : WALL POSTS, FRONT

LOHELALI : WALL PLATE

POU HANA : RIDGE POSTS

HALAKEA : TEMPORARY

RIDGE POSTS

KAUHUUHU : RIDGEPOLE, ALSO

KAUPAKU

O'A : RAFTERS

KAUPAKU 'IOLE : 2ND

RIDGEPOLE

KUKUNA : CABLE POSTS

'AHO PUEO : MAIN PURLINS

'AHO : THATCH PURLINS

'AHO HUI : THATCH PURLINS

SUPPORTS.

* PRONOUNCE EACH

SYLLABLE EVENLY.

'AHO SOUNDS LIKE HAO.

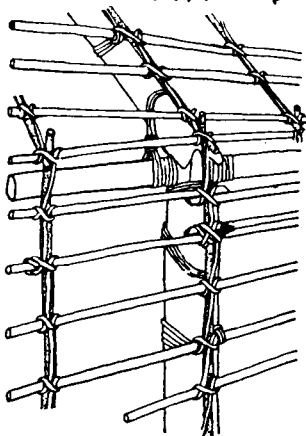

CLOVE HITCH TECHNIQUE W/ PURLINS

THE HIP

The hipped roof differs from the gable roof in that the triangular section above the wall plate slopes inward and upward instead of being vertical. The hipped roof house did not appear in the Islands until after European contact.

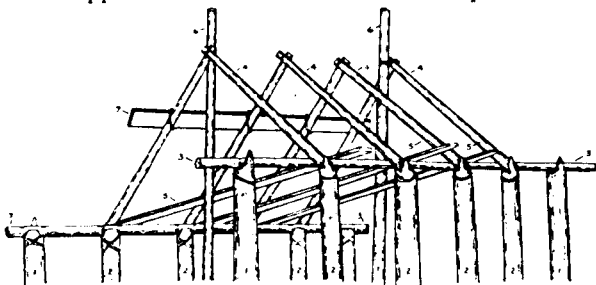

PUTTING UP HIPPED ROOF

INTERIOR POSTS ARE TEMPORARY

1. CORNER POSTS
2. SIDE WALL POSTS
- 2'. END WALL POSTS
3. WALL PLATE
- 3'. END WALL PLATE
4. MAIN RAFTERS
5. MAIN RIDGE POLE
6. 2ND RIDGE POLE
7. HIP RAFTERS
8. MEDIAN END STRUT
9. LATERAL END STRUTS

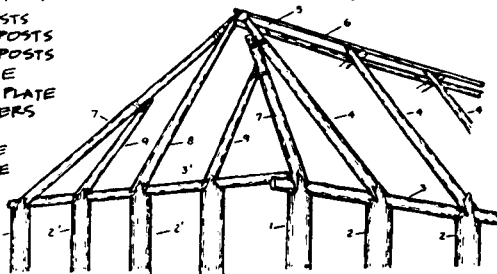

FRAME

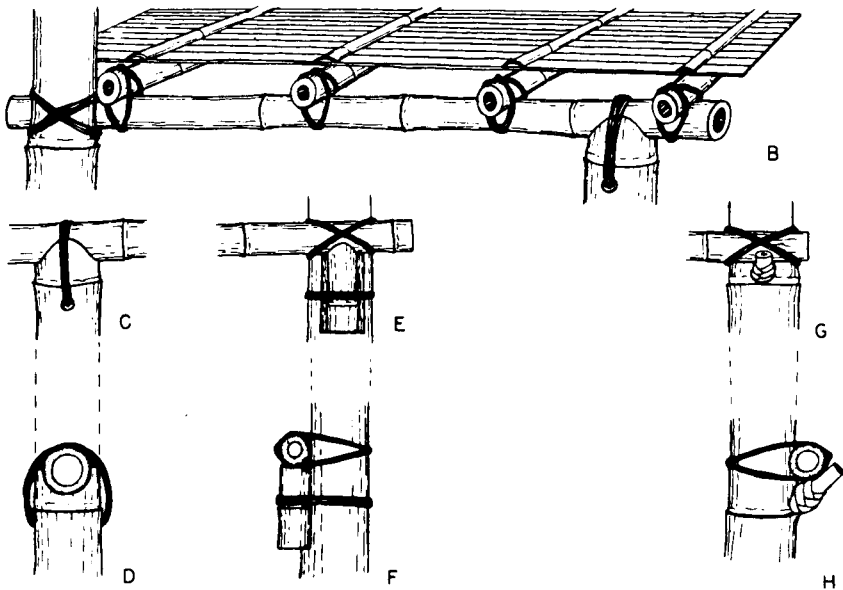
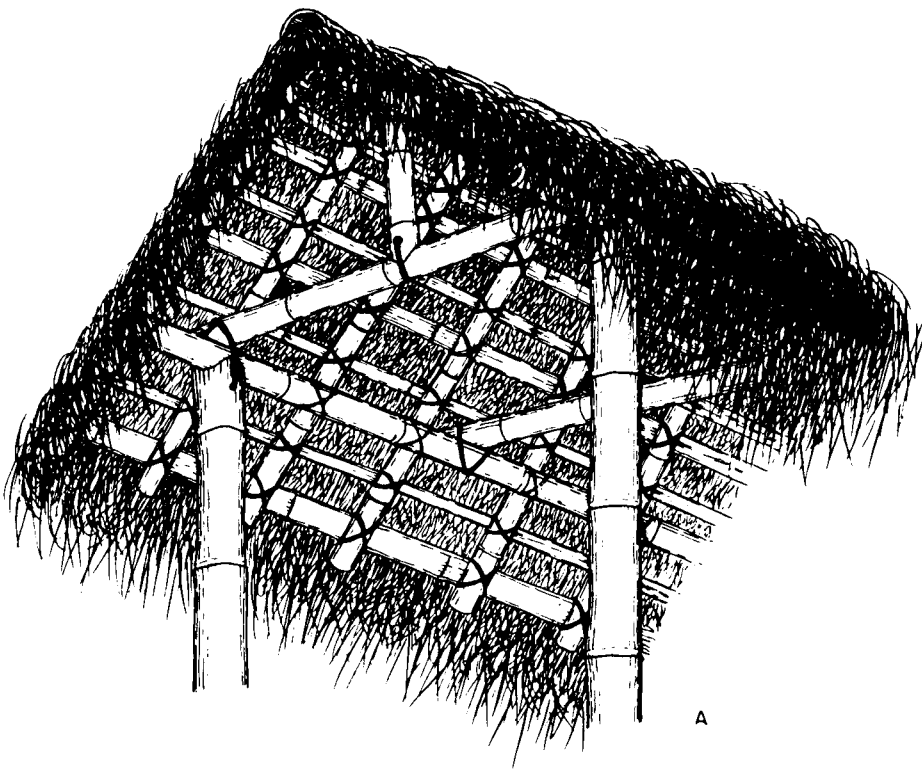
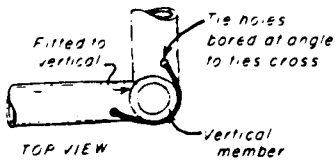
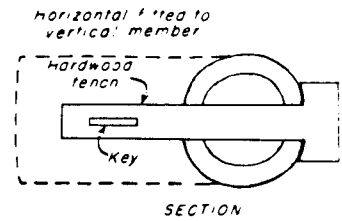
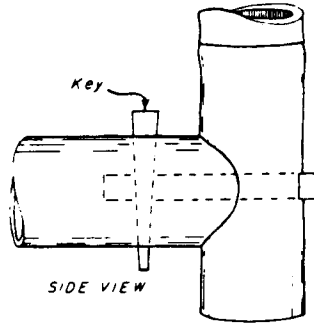

Figure 10 --Details of bamboo construction: A, fitting and binding culms at joints in roof and frame; B, fitting and securing bamboo boards of floor; C and D, saddle joint; E and F, use of inset block to support horizontal load-bearing elements; G and H, use of stump of branch at node of post to support horizontal load-bearing elements.



DOUBLE BUTT TIED JOINT



TENON KEY JOINT FOR HEAVY DUTY OR FINE WORK

JOINT FOR CONNECTION OF SMALL MEMBERS TO LARGE MEMBERS

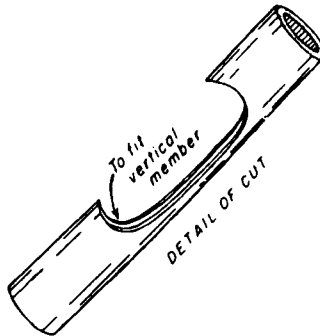
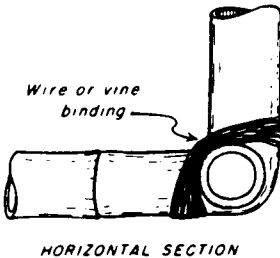
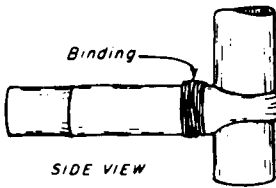
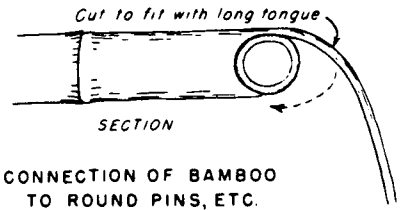
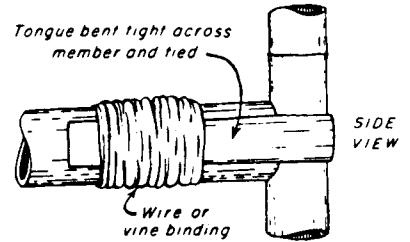
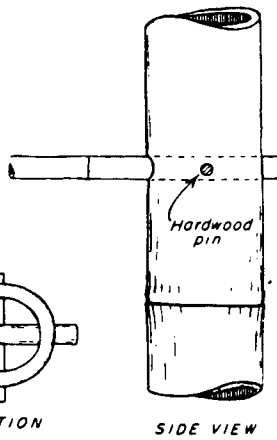
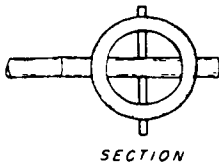

DOUBLE BUTT BENT JOINT
Suitable for furniture and similar uses

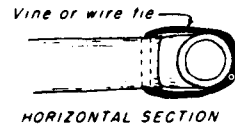
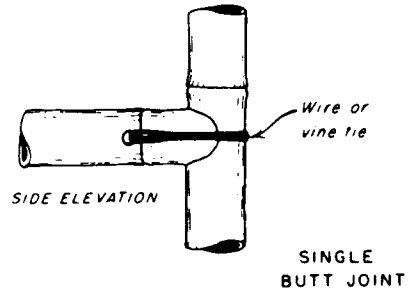

Figure 11 -- Joints used in building with bamboo.

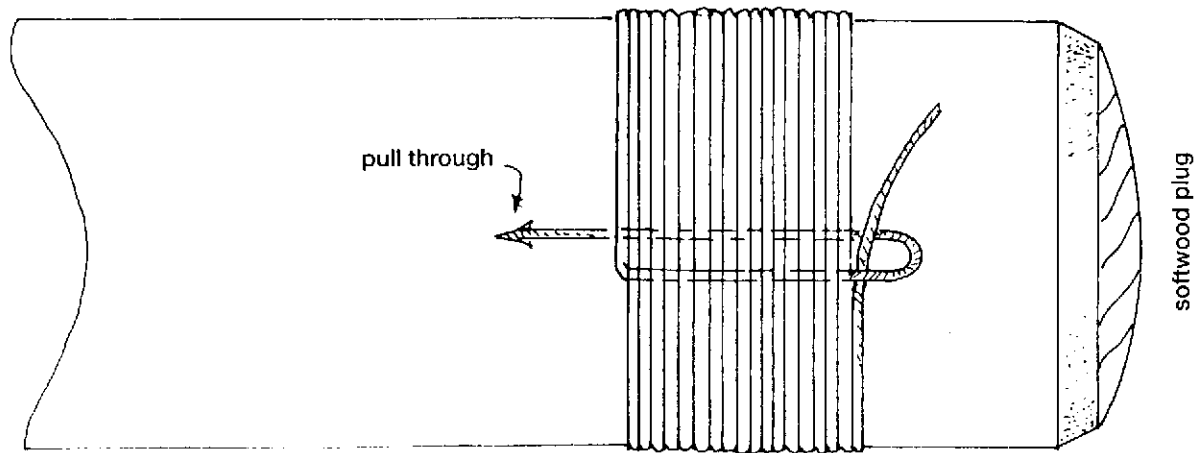
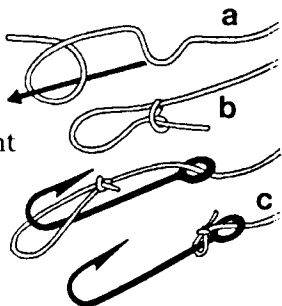

Fig 54 Common whipping at the top of a bamboo pole.

Fishing knots

HOOK ON TO GUT: Turl knot. Soak gut. Thread through eye of hook. Make overhand loop and pass a bight through it (a) to form a simple slip knot (b). Pass hook through slip knot (c) and pull tight round shank.



HOOK ON TO NYLON I: Half blood knot. Thread end through eye. Make 4 turns round standing part. Pass live end through loop formed next to hook (i). Pull taut and snip off fairly close to end (ii).

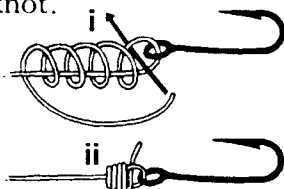

HOOK ON TO NYLON II: Two turn turl knot. Thread hook. Pass live end round standing part to form a loop and through it. Twist live end twice round side of loop. Hold loop and pull twists tight. Pass hook through loop (1). Pull on standing part to tighten loop on hook (2).

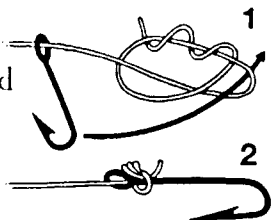

JAM KNOTS: To secure improvised hooks to gut or cord. With an eye: thread gut. Make two turns round hook and bring live end up through turns (a).

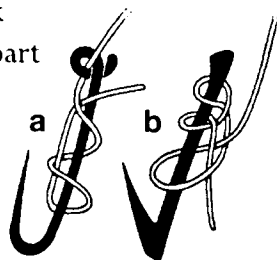

Ease tight and test for strength. Without an eye: make loop round lower part of shaft. Make two half-hitches from upper end downwards and pass live end through lower loop (b). Pull on standing part to tighten.

LOOP IN NYLON I: Double overhand loop. Double line to make a bight. Tie an overhand in it (a). Twist end through again (b). Pull tight (c) and snip off end.

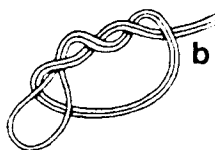
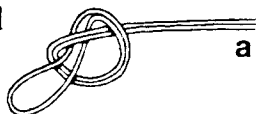

LOOP IN NYLON II: Blood bight. Form a bight. Twist the end of it back round the standing part (i). Bring end back through new loop (ii). Pull tight and snip off loose end.



JOINING LOOPS: With free ends: pass each line through the other loop (1) and pull tight (2). With only one end free: make loop on one line. Take live end of other line through loop, round it and back through and then tie off with either of the knots for hooks on to nylon.

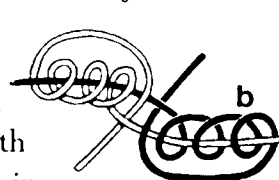
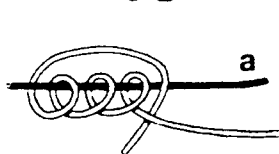

JOINING NYLON: Double three-fold blood-knots. Place ends alongside and twist one three times round the other. Bring live end back and pass it through the space where the two lines cross over the other line and under its own standing end (a). Repeat in the opposite direction with the other line. Live ends then point in opposite directions (b). Ease tight.

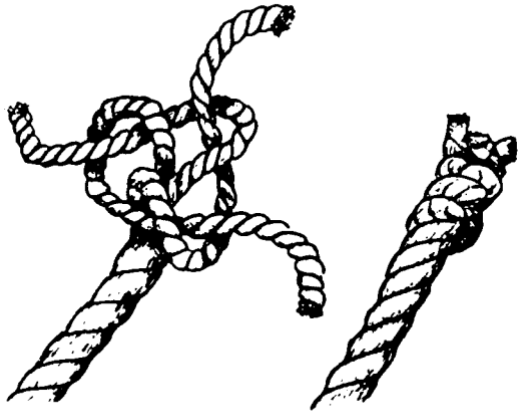

Stopper Knot

SPLICING & WHIPPING

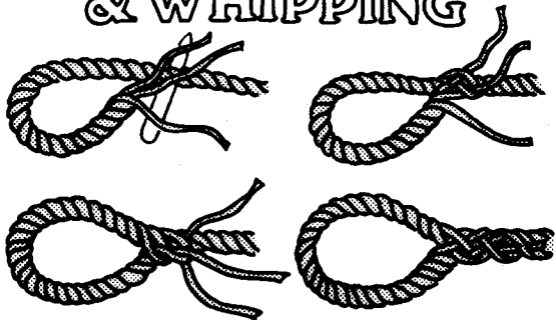

EYE SPLICE: Useful for putting a permanent loop in the end of a rope and for splicing one line, at right angles, into another. First unlay the rope about five turns and bend it back upon itself to form the desired loop. The two outer strands should straddle and the central strand lie on top of the line. Second, raise a strand in the main line and pass the middle loose strand under it, over the second main line strand, under the third, etc. Weave the two outside loose strands in *over* the first main line strand, *under* the second, etc. The finished splice will look like the final drawing above.

THE ESSENTIALS OF A GOOD SPLICE: A good splice must be strong and durable, it must carry the same load as any other part of the rope and—when made out in the middle of a line—it must not increase the rope's diameter enough to bind up in a pulley. Basically, splicing consists of three steps: (1) unlaying the strands of the ends to be joined, (2) fitting the ends together and interlocking their strands and (3) relaying and weaving the strands into a smooth piece of rope. The splice shown above illustrates all three steps and is an exceptionally handy one to know for making lariats, cinch lines for heavy loads, etc.

WHIPPING: To prevent a rope from unraveling, form a blight in a piece of twine and hold it 1/4" from the rope's end. Wrap the other end of the twine around the rope until the length of whipping equals the larger line's diameter. Place end of twine through the exposed loop, pull the loop under the whipping and trim loose end.

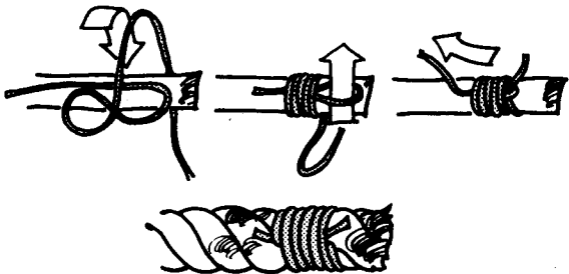

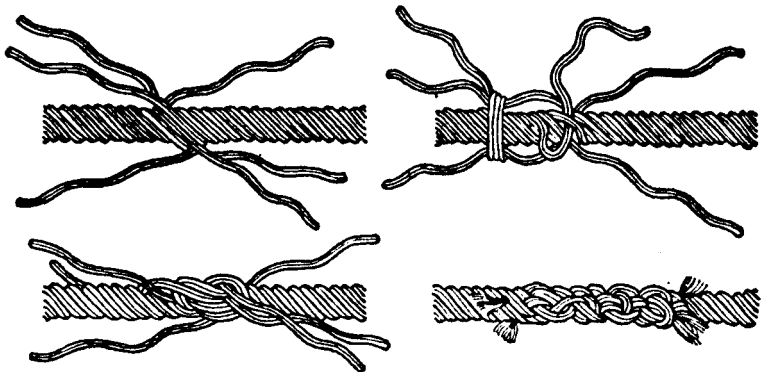

(k) short splice

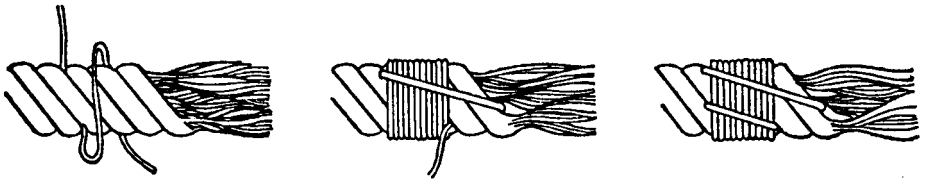

(l) palm and needle whipping

ROPE SPLICING. When two pieces of rope are joined by unlaying the strands and weaving or intertwining the strands of one end with those of the other, the operation is known as *splicing*. Ordinarily the object of splicing is to join the rope ends without increasing the size at the joint, as when a knot is employed. There are two kinds of splices in common use which are known as the "short splice" and the "long splice." The short splice may be made more rapidly than the long one, but the joint or

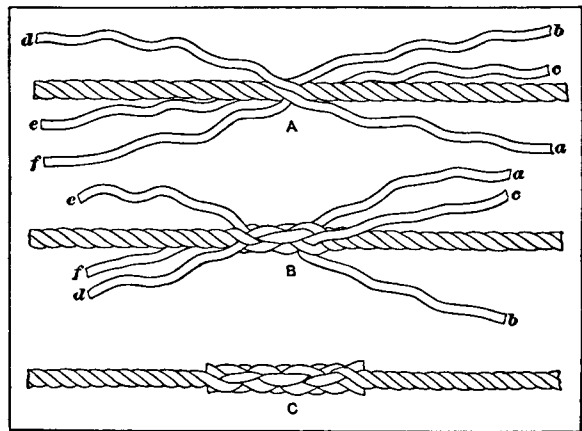

Fig. 1. Method of Making a Short Splice

splice is somewhat larger in diameter than the rest of the rope, whereas, a long splice, if properly made, can scarcely be detected.

Making a Short Splice.— The first step in making a short splice is to unlay or untwist the strands at the end of each rope. The two ends are then placed together as indicated at *A* in Fig. 1, so that each strand lies between two strands of the other rope. The distance that each end should be unlayed, or the length of the untwisted strands, depends upon the diameter of the rope, but the proportion should be about as indicated in the illustration. It is better to have a little extra length, since the projecting ends, in any case, are finally cut off. After the ropes are placed together, as shown at *A*, the strands on one side, as shown at *d*, *e*, and *f*, are either held together by the left hand or are fastened together with twine, in case the rope is too large to be held by the hand. The splicing operation is started by taking one of the strands as at *a*, and passing it across or over the adjacent strand *d* and then under the next strand *e*, after having made an opening beneath strand *e*. The strands *b* and *c* are next treated in the same manner, first one and then the other being passed over its adjoining strand and then under the

next successive one. These same operations are then repeated for the strands *d*, *e*, and *f* of the other rope. The splice will now appear as shown at *B* in the illustration. In order to make it stronger and more secure, the projecting strands of each rope are again passed diagonally over the adjoining strands and under the next successive ones. The splice should then be subjected to a strong pull, in order to tighten the strands and make them more compact. The projecting ends of the strands should then be cut off,

passing them over the adjoining strand and through the rope, under the next one. By gradually removing the fiber each time the end is passed across an adjoining strand, the enlargement of the rope at this point may be made very slight and scarcely noticeable. The strands *f* and *g* which remain in their original positions in the center of the splice, and also the strands *c* and *d* are disposed of in a similar manner, thus completing the splice as shown at *C*.

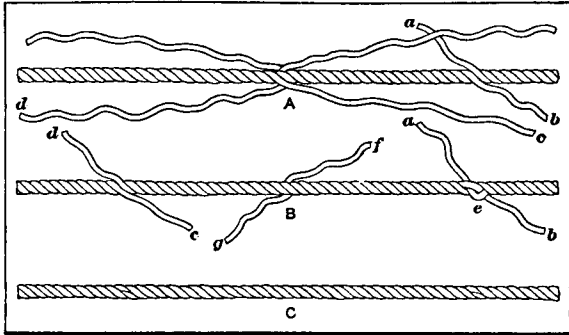

Fig. 2. Views illustrating how a Long Splice is made

thus completing the splice as shown at *C*. For making the openings beneath the strands on the rope, what is known as a *marlin spike* is generally used. This is merely a tapering, pointed pin made of wood or iron.

Making a Long Splice. — When a rope has to pass through pulley blocks, or in case any increase in the size of the rope would be objectionable, the short splice is not suitable and the long splice should be employed. The diameter of a long splice is the same as that of the rope and, if the work is done carefully, the place where the ends are joined can scarcely be distinguished from the rest of the rope. The ends of each rope are first unlaied or untwisted the same as when making a short splice, but for a distance about three times as long. These ends are then placed together so that each strand lies between two strands of the other rope, the same as shown at *A*, Fig. 1, for a short splice. One of the strands is next unlaied and then a strand from the other rope is curled around into the groove thus made, as indicated at *A* in Fig. 2, strand *a* having been unlaied and strand *b* from the other rope end, put into its place. Care should be taken to twist strand *b* so that it will lie in its natural position into the groove previously occupied by strand *a*, as the neatness of the splice will depend partly upon the care with which this part of the work is done. This operation is then repeated in connection with strands *c* and *d*, strand *c* being unlaied and strand *d* twisted around to occupy the groove thus made. The splice will now be as shown at *B*, and the next step is that of disposing of the protruding ends of the strands. After these strands have been cut to about the length shown at *B*, two of the strands, as at *a* and *b*, are first reduced in size by removing about one-third of the fiber; these ends are then tied by an overhand knot as shown at *e*. After tightening this knot, the protruding ends may be disposed of the same as when making a short splice, or by

Making an Eye-splice. — When a loop is formed at the end of a rope by splicing the free end to the main or standing part of the rope, this is known as an *eye-splice*. The end of the rope is first unlaied about as far as it would be for making a short splice. After bending the end around to form a loop of the required size, the middle strand *a* (Fig. 3) is tucked under a strand on the main part of the rope, as illustrated at *A*. The strand *b* is next inserted from the rear side under the strand on the main part which is just above the strand under which *a* was inserted. Since strand *b* is pushed under the strand on the main part from the rear side, it will come out at the point where strand *a* went in, as illustrated at *B*. The third strand *c* is now passed over the strand under which strand *a* was inserted, and then under the next successive one, as illustrated at *C*. These three strands are next pulled taut and then about one-third of the fiber should be cut from them; they are next tucked away the same as when making a short splice, that is, by passing a strand over its adjoining one and under the next successive strand. The reason for cutting away part of the fiber or yarns is to reduce the size of the splice and give it a neater appearance. By gradually thinning out the fiber, the overlapping strands may be given a gradual taper, as indicated at *D*, which shows the completed eye-splice.

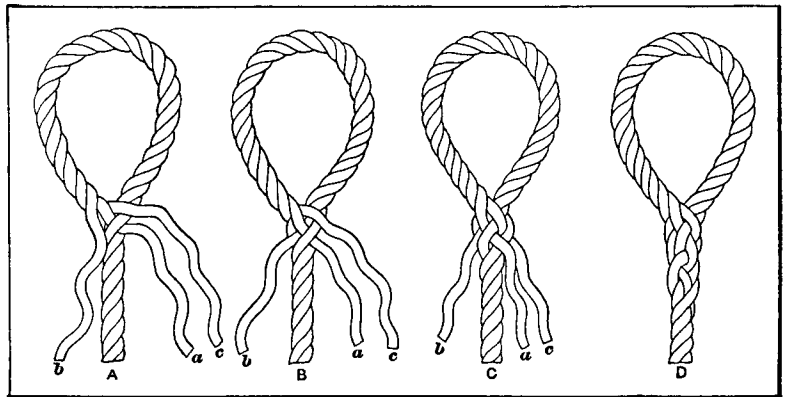

Fig. 3. Method of Making an Eye-splice

Splicing Transmission Rope. — The splice in transmission rope must be of the same diameter as the original rope and it should be smooth and free from lumps. What is known as the *English transmission splice* will be described, the rope selected being a four-strand Manila rope 1½ inch in diameter, which is to be spliced on the sheaves such as are used with the multiple system of rope transmission. The rope is first placed around the sheaves and with tackle it is stretched and hauled taut. The ends should pass each other from 6 to 7 feet, the passing point being marked by tying twine around each rope. The rope is then removed from the sheaves and allowed to rest on the shaft so that there will be sufficient slack for making a splice.

First unlay the strands in pairs as far back as the pieces of twine *a* and *b* (see diagram A, Fig. 4). The ends of the rope are now placed together, as at A, and the cores which pass through a rope of this kind are drawn out together on one side. After having removed the marking twine, unlay the two strands *i* and *j* back for a distance of two feet or to a point *k* (see diagram B). The pair of strands *c* and *d* should be carefully laid in the place of strands *i* and *j*. Next unlay the strands *g* and *h* back for a distance of two feet or to point *l* and replace them with strands *e* and *f*. The rope is now as shown at B.

The pair of strands *i* and *j* are next separated and *j* is unlay back a distance of four feet to point *m* which is six feet from the center. (See illustration C.) The strand *i* is left at *k*. The pair of strands *c* and *d* are next separated and *d* is left at point *k* with strand *i*, whereas strand *c* is carefully laid in place of strand *j* until they meet at point *m*. The two pairs of strands *e* and *f* and *g* and *h* are now separated and laid in the same manner, care being taken to maintain the original twist and lay of each strand. The protruding cores that extend through the center of the rope are cut off so that the ends, when pushed back into the rope, butt together. The rope now appears as shown at C, and after the eight strands have been cut to convenient working lengths (about two feet) the companion strands, such as *c* and *j*, *d* and *i*, etc., are ready to be fastened together and tucked. This operation will be described for strands *e* and *h*, the method being identical for the other three pairs. Unlay strands *e* and *h* for a length of about from 12 to 14 inches and divide each strand in half by removing its cover yarns as indicated at D. Whip or bind with twine the ends of the interior yarns of *e* and *h*; then, leaving the outer cover, re-lay strand *e* until it is near strand *h* and then join these strands with a simple knot, as indicated at E. Next divide the cover yarns of strand *h* and pass *e* through them, as at F, continuing on through the rope under the two adjacent strands, avoiding the core.

The half strand *h* is now taken care of as follows: At the right of the knot made with strands *e* and *h*, strand *e* is raised slightly by using a marlin spike and *h* is passed or tucked around *e* two or three times so that these two half strands form a whole strand. Half strand *h* is tucked until the cover of *e* is reached, which is shown at the right in diagram F; the yarns of this cover are then divided and strand *h* is passed through them and drawn under the two adjacent strands, thus locking it the same as was done with strand *e*. Both of these strand ends are now cut off leaving about two inches so that the yarns may draw slightly without unlocking. This completes the joining of one pair of strands as indicated at G. The three remaining pairs are joined in the same manner. After the transmission rope has been in service for a few days, the projecting ends at the locks wear away, and if the tucks have been made carefully and the original twist of the yarns preserved, the diameter of the rope will not be increased appreciably, nor can the splice be located when the rope is in motion.

Splicing Wire Rope.—The following directions for splicing wire rope are given by the American Steel & Wire Co. It is first necessary to determine the length of the splice. The allowance depends upon the rope diameter and should be about as follows: For diameters of $\frac{3}{8}$ or $\frac{1}{2}$ inch, 16 feet; $\frac{5}{8}$ -inch diameter, 20 feet; $\frac{3}{4}$ -inch, 24 feet; $\frac{7}{8}$ -inch, 28 feet; 1-inch, 32 feet; $1\frac{1}{8}$ -inch, 36 feet; $1\frac{1}{4}$ -inch,

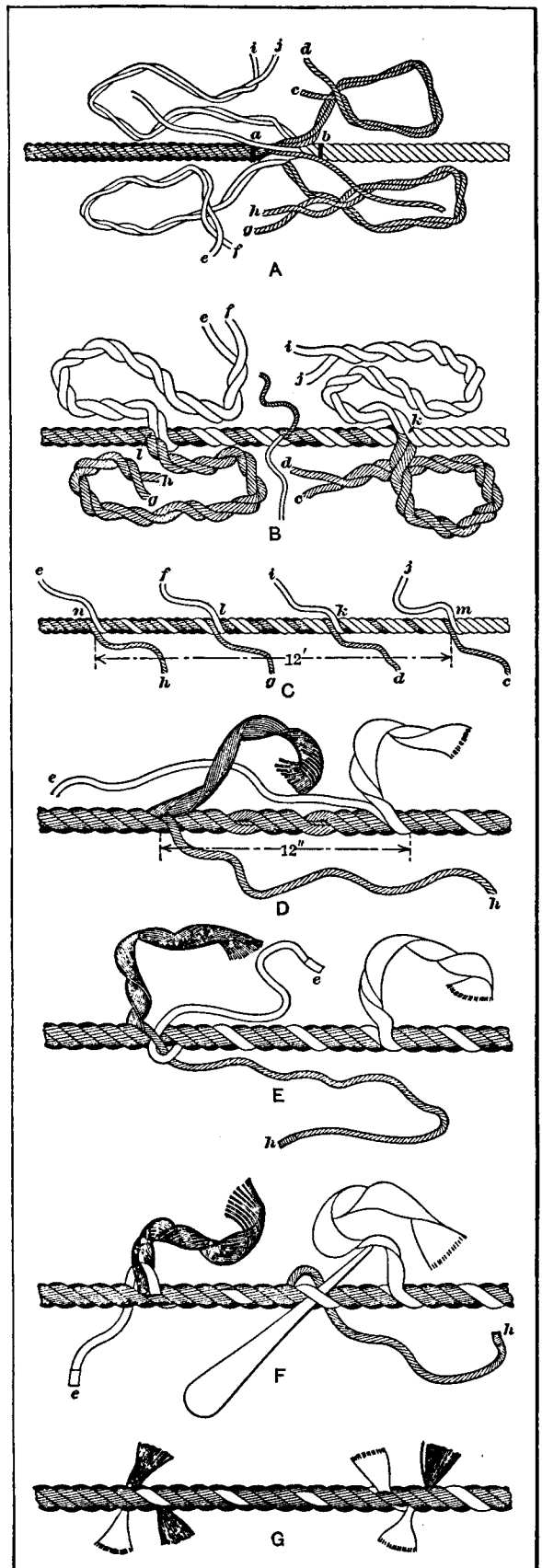

Fig. 4. Splicing Manila Transmission Rope

40 feet; $1\frac{1}{2}$ -inch, 44 feet. This extra length is equal to the distance $a-b$ (see Fig. 5). Before making a splice, the required length of the rope after splicing should be carefully measured and marked at the points c and d . The strands are next unlaied from each end a and b as far as the marks c and d . There are usually six strands in wire rope, and these are laid together around a hemp center or core. After the strands have been unlaied, the projecting hemp centers should be cut off at c and d . The two rope ends are next placed together so that a strand of each rope is between two other strands and the marks c and d meet, as indicated at B . Next unlay a strand from one end and follow by laying the strand opposite and be-

laying each pair of strands as previously described to tie them temporarily at the points e and f .

This process of unlaying one strand and replacing it by a corresponding strand from the opposite side is repeated for each of the remaining four pairs of strands in the center; one pair should be carried back to a point g , another to a point h on the opposite side of the center, and the two remaining pairs should be stopped at points i and j in order to divide the space between e and f into approximately five equal parts, as shown at D . The ends in each case are cut off so that the strands extend beyond the main part of the rope a distance in inches equal to the length of the splice in feet.

Securing the Ends of the Strands. —

Up to this point, all methods of making long splices are practically the same. They differ, however, in regard to the method of securing the ends of the strands. One good method is to insert the ends into the center of the rope after removing part of the hemp center or core. The rope is first clamped in a vise at a point to the left of the two strands (as at the left of e), and, by means of a hand clamp applied near e , the rope should be opened up by untwisting it sufficiently to permit cutting the hemp core which is then seized with nippers and a short length drawn out. The two nearest strands should then be opened up by inserting a marlin spike, after which the loose strand is started into the open space left vacant by the hemp center. By rotating the marlin spike, the projecting end of the strand may be placed completely in the center. After cutting the hemp core where the strand ends, the core should be pushed into place. The clamps are next removed, thus allowing the rope to close around the core. The hemp core is now drawn out in the opposite direction and the other strand is laid in the center of the rope in the same manner. After repeating this operation at the five remaining points g , i , j , etc., the rope should be hammered lightly at these points with a small wooden mallet, which com-

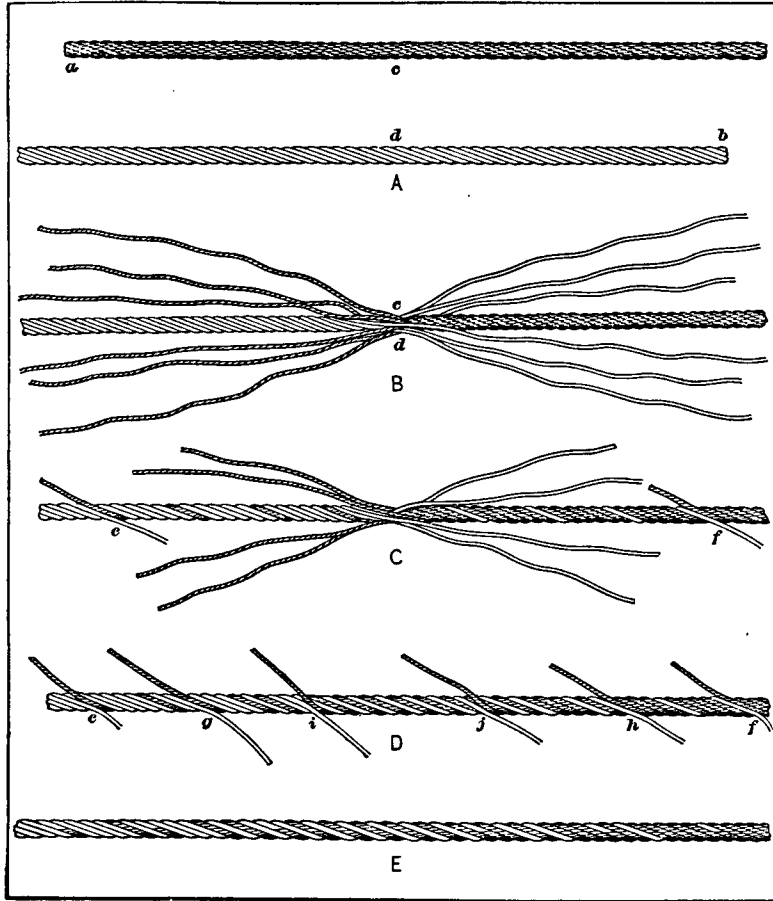

Fig. 5. Method of Splicing a Six-strand Wire Rope

pletes the splice. A rope spliced by this method will be nearly as strong as the original rope and after it has been in use a few days, the splice, if carefully made, can scarcely be detected. If a clamp and vise are not available for this work, two rope slings and short wooden levers may be used to untwist and open the rope.

longing to the other rope into the seam or groove thus formed; this operation should be continued until there remains a length of strand having a length in inches approximately equal to the total length of the splice in feet. For instance, if the splice were 16 feet long the following strand or the one that is inlaid should have a projecting end about 16 inches long. The strand which was unlaied to form a groove for the inlaid strand should be cut off to about the same length at the point where the two strands meet. An adjacent strand is next unlaied in the opposite direction from the center of the splice and the corresponding opposite strand is laid in its place, after which the two ends are cut off as previously described. As this is a six-strand rope, four of the strands now terminate at e and f , as illustrated at C , and eight strands remain in the center of the splice. It is advisable after